

1. Product Description

Nexto Series is a powerful and complete Programmable Logic Controller (PLC) Series with unique and innovative features. Due to its flexibility, smart design, enhanced diagnostics capabilities and modular architecture, Nexto is suitable for control systems ranging from medium to high-end large applications. Finally, its compact size, high density of points per module and superior performance, allow Nexto Series to be applied in small automation systems with high performance requirements, such as manufacturing applications and industrial machines.

The Series has a wide variety of CPUs, I/O and communication modules with features to fit requirements in different kinds of applications. The options available cover from standard automation systems, high-availability applications where redundancy is a major requirement, distributed applications to functional safety systems.

This module offers 4 individually configurable current analog outputs with HART, occupying just one position in the rack. In addition to making it possible to control field actuators via the conventional 0-20mA signal, these outputs also make it possible to communicate HART with the instruments via the CPU's Ethernet port using an asset management tool that supports DTM technology. The Nexto Series DTM is available to be downloaded on the website www.altus.com.br.

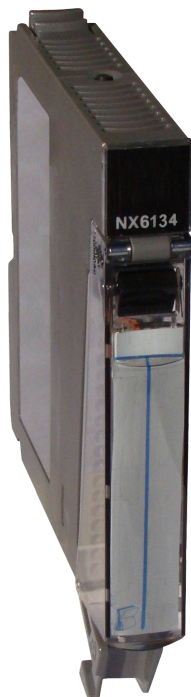

Its main features are:

- 04 outputs in a single width module
- Support for different current scales: 0 to 20 mA and 4 to 20 mA
- HART Protocol(4-20mA)
- Individual configuration per output
- Software parameterizable filters
- Galvanic isolation between outputs and internal logic
- Surge protection
- Open loop diagnosis
- Display for module diagnostics and output state indication
- Easy Plug System
- One Touch Diag
- Electronic Tag on Display

2. Ordering Information

2.1. Included Items

The product package contains the following items:

- NX6134 module
- 20-terminal connector with wire holder

2.2. Product Code

The following code should be used to purchase the product:

Code	Description
NX6134	4 AO Current Module 16 Bits with HART

Table 1: Product Code

3. Related Products

The following product must be purchased separately when necessary:

Code	Description
NX9403	20-terminal connector with cable guides

Table 2: Related Products

4. Innovative Features

Nexto Series brings to the user many innovations regarding utilization, supervision and system maintenance. These features were developed focusing a new concept in industrial automation.



Easy Plug System: Nexto Series has an exclusive method to plug and unplug I/O terminal blocks. The terminal blocks can be easily removed with a single movement and with no special tools. In order to plug the terminal block back to the module, the frontal cover assists the installation procedure, fitting the terminal block to the module.



One Touch Diag: One Touch Diag is an exclusive feature that Nexto Series brings to PLCs. With this new concept, the user can check diagnostic information of any module present in the system directly on CPU's graphic display with one single press in the diagnostic switch of the respective module. OTD is a powerful diagnostic tool that can be used offline (without supervisor or programmer), reducing maintenance and commissioning times.

ETD – Electronic Tag on Display: Another exclusive feature that Nexto Series brings to PLCs is the Electronic Tag on Display. This new functionality brings the process of checking the tag names of any I/O pin or module used in the system directly to the CPU's graphic display. Along with this information, the user can check the description, as well. This feature is extremely useful during maintenance and troubleshooting procedures.

5. Product Features

5.1. General Features

	NX6134
Backplane rack occupation	1 slot
Number of outputs	4 analog outputs
Output type	Current output, single-ended, individually configured
Data format	16 bits in two's complement, justified to the left
Converter resolution	16 bits monotonicity guaranteed, no missing codes
Configurable parameters	Signal type per output
Output state indication	Yes
One Touch Diag (OTD)	Yes
Electronic Tag on Display (ETD)	Yes

	NX6134
Status and diagnostic indication	Display, web pages and CPU's internal memory
Hot swap capability	Yes
Module protection	Yes, protection against voltage surges
Wire gauge	0,5 mm ² (20 AWG)
Minimum wire temperature rating	75 °C
Wire material	Copper only
Isolation	
Outputs to logic	1000 Vac / 1 minute
Outputs to protective earth ⊕	1000 Vac / 1 minute
Logic to protective earth ⊕	1000 Vac / 1 minute
Outputs to power supply	1000 Vac / 1 minute
Current consumption from backplane rack	250 mA
External power supply	19,2 to 30 Vdc
External power supply current	200 mA @ 24 Vdc
Maximum power dissipation	3 W
IP level	IP 20
Operating temperature	0 to 60 °C
Storage temperature	-25 to 75 °C
Operating and storage relative humidity	5% to 96%, non-condensing
Conformal coating	Yes
Module dimensions (L x A x P)	18,00 x 114,62 x 117,46 mm
Package dimensions (L x A x P)	25,00 x 122,00 x 147,00 mm
Weight	200 g
Weight with package	250 g

Table 3: General Features

Notes:

External Power Supply: Terminals 19 and 20 are used to supply power to the outputs only. The module's internal logic is supplied by the Power Supply Module placed on the Nexto Backplane Rack.

ATTENTION

If the external power supply is below the 19.2 V limit, the outputs go to a safe state. However, since the display only shows the outputs' logical state, its indication may not match the physical state of outputs.

Conformal Coating: Conformal coating protects the electronic components inside the product from moisture, dust and other harsh elements to electronic circuits.

Wire gauge: Crimp terminals for 0.5 mm² wire in each way respecting as described at Nexto Series User Manual - MU214600.

5.2. Standards and Certifications

Standards and Certifications	
IEC	61131-2: Industrial-process measurement and control - Programmable controllers - Part 2: Equipment requirements and tests
EAC	TR 004/2011 (LVD) CU TR 020/2011 (EMC)

Table 4: Standards and Certifications

5.3. Current Mode Features

	NX6134 – Current Mode	
	Range	Resolution
Output ranges	0 to 20 mA	366,21 nA
	4 to 20 mA	366,21 nA
Precision	±0,1% of full scale rating @ 25 °C ±0,005% of full scale rating / °C	
Scanning time	1,25 ms	
Stabilization time	1 ms	
Maximum output value	21 mA	
Load impedance	< 600 Ω	

Table 5: Current Mode Output Features

Note:

Output Ranges: The presented resolutions are the optimal delivered by the hardware.

5.4. HART

	NX6134
Operating mode	Master/Slave (point to point)
Enables secondary master	Yes

Table 6: HART features

5.5. Compatibility with Other Products

The following table provides information regarding the compatibility of the module and Nexto Series programming tool MasterTool IEC XE.

NX6134		Compatible Software Version
Version	Revision	MasterTool IEC XE
1.0.1.0 or higher	AC or higher	3.52 or higher

Table 7: Compatibility with Other Products

5.6. Physical Dimensions

Dimensions in mm.

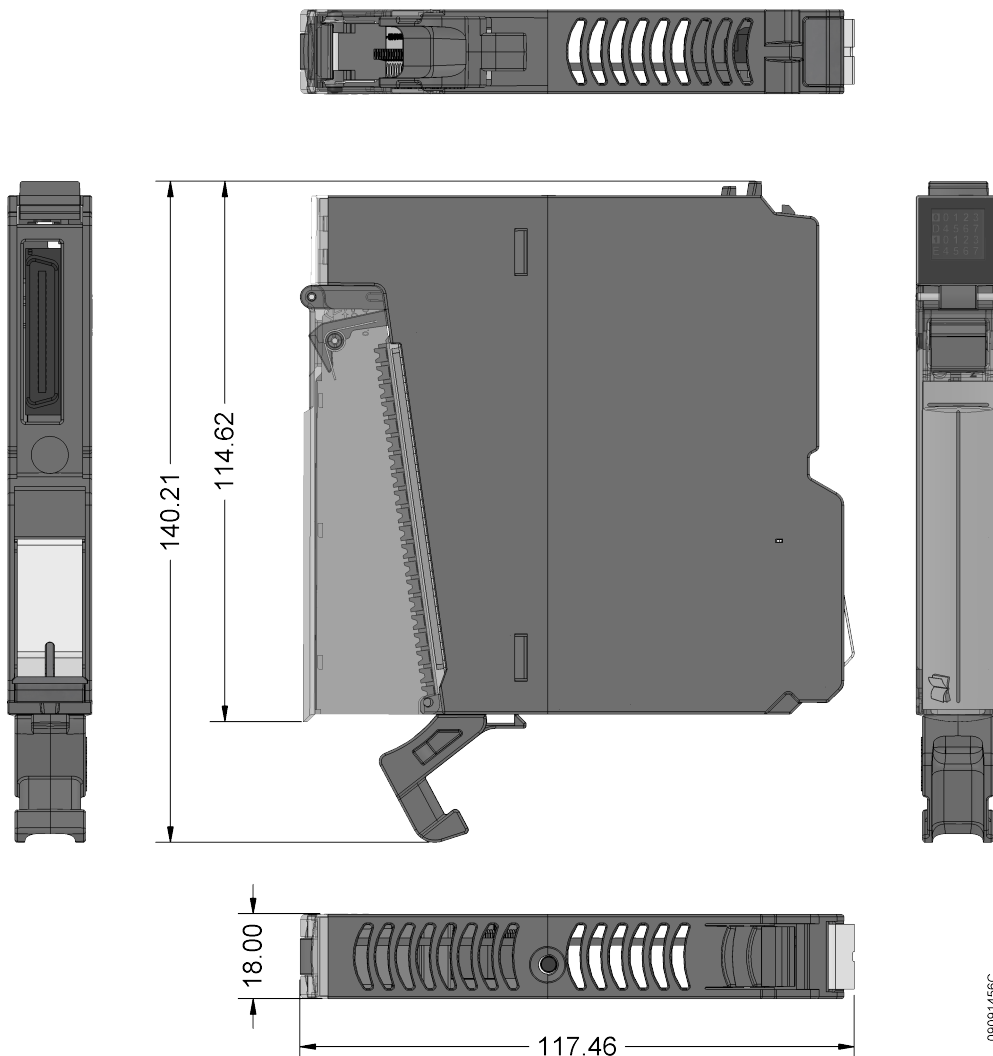

Figure 1: Physical Dimensions

6. Installation

For the correct installation of this product, it is necessary to use a rack (backplane rack) and it must be carried out according to the mechanical and electrical installation instructions that follow.

6.1. Product Identification

This product has some parts that must be observed before installation and use. The following figure identifies each of these parts.

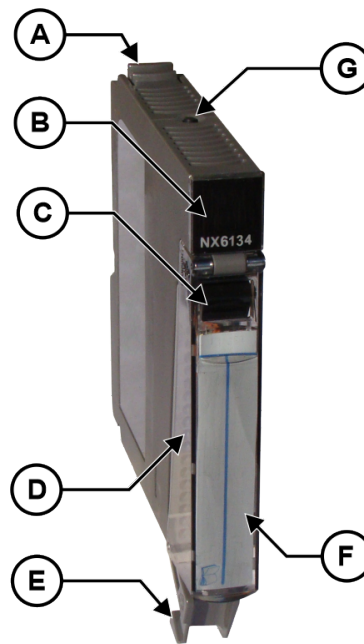

Figure 2: NX6134

- Ⓐ Fixing lock.
- Ⓑ Status and diagnostic display.
- Ⓒ Terminal block extraction lever.
- Ⓓ Front cover.
- Ⓔ 20 pin terminal block with wire holder.
- Ⓕ Label for module identification.
- Ⓖ Diagnostic switch.

The product has in its mechanics a label that identifies it and in it are presented some symbols whose meaning is described below:

⚠ Attention! Before using the equipment and installing, read the documentation.

=== Direct Current.

6.2. Electrical Installation

The figure below shows an example using two outputs. All in current mode.

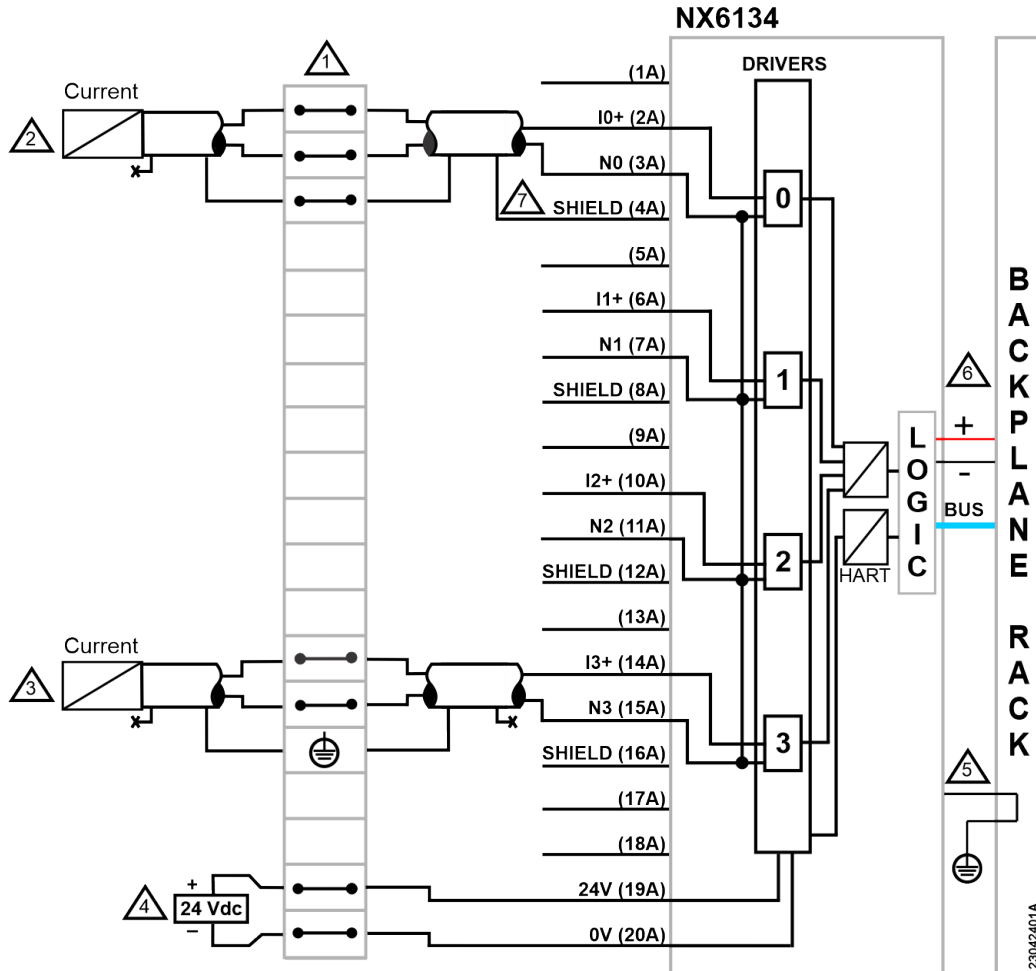





Figure 3: Electric Diagram

Diagram Notes:

- ① The diagram above has the representation a set of terminal blocks where each symbol represents a different kind of terminal block:  represents a standard connection terminal block and  represents a grounding terminal block.
 - ② The current output mode uses the I and N pins. The shielded cable of output 00 is connected to the shield pin.
 - ③ The current output mode uses the I and N pins. The shielded cable of output 03 is connected to the ground terminal block.
 - ④ The external power supply is connected to pins 19A and 20A.
 - ⑤ The module is connected to protective earth  through the backplane rack.
 - ⑥ The module's power supply is derived from the connection to the rack and requires no external connections.
-  Protective earth terminal.

6.3. Connector Pinout

The following table shows the description of each connector terminal:

Terminal	Description
1A	NC
2A	Current output 00
3A	Reference output 00
4A	Shield
5A	NC
6A	Current output 01
7A	Reference output 01
8A	Shield
9A	NC
10A	Current output 02
11A	Reference output 02
12A	Shield
13A	NC
14A	Current output 03
15A	Reference output 03
16A	Shield
17A	NC
18A	NC
19A	24 Vdc
20A	0 Vdc

Table 8: Connector Pinout

Note:

NC: All NC pins must not be connected.

6.4. Protection Circuit

For further information, consult the "Lightning Protection" section of the Nexto Series User Manual - MU214600.

ATTENTION

Atmospheric discharges (thunders) may cause damages to the product although its protections. Additional protections should be used if the product's power comes from a power supply located outside the panel where it is installed because it could be vulnerable to this kind of discharges. If the field wiring of the output points is susceptible to this kind of discharge, surge suppressors should be used.

6.5. Mechanical and Electrical Assembly

The mechanical and electrical mounting and the connector pin insertion and removing for single hardware width I/O modules are described at Nexto Series User Manual – MU214600.

ATTENTION

Products with broken warranty seal are not covered in warranty.

CAUTION



The device is sensitive to static electricity (ESD). Always touch in a metallic grounded object before handling it.

DANGER



Nexto Series can operate with voltage up to 250 Vac. Special care must be taken during the installation, which should only be done by qualified technical personnel. Do not touch on the wiring field when in operation.

7. Configuration

This module was developed to be used with Nexto Series products. All Nexto Series products are configured in MasterTool IEC XE. All configuration data of a given module can be accessed through a double click in it on the Graphical Editor.

7.1. Process Data

Process Data are the variables used to access the module. The table below describes all the variables made available by this module when declared on the CPU or MODBUS Head bus.

In addition to the data in the table, this product also provides a set of variables containing information related to diagnostics, which are also described in this document.

Variable	Size	Process Data	Description	Type	Update
%QW(n)	WORD	AO 00	Analog Output 00	INT (Read/Write)	Always
%QW(n+2)	WORD	AO 01	Analog Output 01	INT (Read/Write)	Always
%QW(n+4)	WORD	AO 02	Analog Output 02	INT (Read/Write)	Always
%QW(n+6)	WORD	AO 03	Analog Output 03	INT (Read/Write)	Always

Table 9: Process Data

Note:

Update: The "Update" field indicates whether the respective process data is updated by default by the CPU and the module. When set to "Always", this means that the process data is always updated. When set to "Selectable", it means that the user can select whether the respective process data is updated or not. All this process data is exchanged between the CPU and the module via the bus to improve the performance of the CPU. It is recommended to update only the process data that will be used in the application.

7.1.1. PROFIBUS Data

When the module is inserted on the bus of a PROFIBUS Head, the variable type will be WORD. In this case, we recommend using symbolic variables of type INT, declared with the AT directive at the same addresses as the direct variables. Example, considering the direct variable %QW(n) from the previous table:

```
iChannel_0 AT %QW(n) : INT;
```

The values sent by PROFIBUS are of the integer type and are fixedly configured in the -30,000 to +30,000 range. For example, on a channel configured as current 0 to 20 mA, the value of -30,000 will be converted to a current value of 0 mA, while the value of +30,000 will be converted to a current value of 20 mA.

7.2. Module Parameters

Name	Description	Standard Value	Options	Configuration
Type	Set Analog Output Type	Current 4 - 20 mA with HART	Not Configured Current 0 - 20 mA Current 4 - 20 mA Current 4 - 20 mA with HART	Per output
Min Value	Engineering Unit Scale – Minimum Value	0 (see note)	-	Per output
Max Value	Engineering Unit Scale – Maximum Value	30000	-	Per output
%Q Start Address of Module Diagnostics Area	Defines the start address of the module diagnostics area	-	-	Per module

Table 10: Module Parameters

Note:

Configuration: The configuration indicates if the parameter is related to the entire module (per module) or if it is related to a single output (per output). In the case of output parameters, all parameters will be repeated for each available output.

Min and Max Value: These parameters can be configured in any value from -30000 to 30000, as long as the Max Value is larger than the Min Value. In PROFIBUS-DP remote, the minimum and maximum values are fixed at -30000 and 30000, respectively.

8. Usage

8.1. General Purpose Output Write

The module has one variable for each output. The parameters Min Value and Max Value are used by the module to convert the engineering value to the analog output value.

9. Maintenance

Altus recommends that all modules' connections should be checked and any dust or any kind of dirt in the module's enclosure should be removed at least every 6 months.

This module offers five important features to assist users during maintenance: Electronic Tag on Display, One Touch Diag, status and diagnostics indicators, web page with complete status and diagnostics list, and diagnostics mapped to internal memory.





9.1. Electronic Tag on Display and One Touch Diag

Electronic Tag on Display and One Touch Diag are important features that provide to the user the option to check the tag, description and diagnostics related to a given module directly on the CPU display.

Electronic Tag on Display and One Touch Diag are easy-to-use features. To check the tag and diagnostics of a given module, it's required only one short press (shorter than 1 s) on its diagnostic switch. After pressing once, CPU will start to scroll tag information and diagnostic information of the module. To access the respective module description just long press (longer than 1 s) the diagnostics switch of the respective module.

More information about Electronic Tag on Display and One Touch Diag can be found at User Manual of each respective CPU (listed at manual of Nexto Series - MU214600).

9.2. Status and Diagnostics Indicators

Nexto I/O modules have a display with the following symbols: D, E,  and  and numerical characters. The states of the symbols D, E,  and  are common for all Nexto Series I/O modules. These states can be consulted in the table below.

9.2.1. D and E States

D	E	Description	Cause	Solution	Priority
Off	Off	Display failure or module off	<ul style="list-style-type: none"> - Module disconnected; - External power supply failure; - Hardware failure. 	Check: <ul style="list-style-type: none"> - If the module is completely connected to the rack; - If the rack is powered by an external source; - If the module has external power. 	-
On	Off	Normal use	-	-	9 (Lower)
Blinking 1x	Off	Active diagnostics	There is at least one active diagnostic related to the module.	Check what the active diagnostic is. More information can be found at section Diagnostics Through Variables .	8

D	E	Description	Cause	Solution	Priority
Blinking 2x	Off	No I/O data update	<ul style="list-style-type: none"> - CPU in STOP mode; - Head/Remote in non-ACTIVE state. 	Check: - If the CPU is in operation; - If the Fieldbus Master is in operation; - The integrity of the network between the MODBUS Client and the Head/Remote.	7
Blinking 3x	Off	Reserved	-	-	6
Blinking 4x	Off	Non-fatal fault	Failure in some hardware or software component, which does not have impact on the basic functionality of the product.	Check the module's diagnostic information. If it is a hardware failure, have the part replaced. If it's software, contact Technical Support.	5
Off	Blinking 2x	Loss of bus master	Loss of communication between: <ul style="list-style-type: none"> - The module and the CPU; - The module and the Head/Remote; - The Head/Remote and the Field Network Master. 	Check: - If the module is completely connected to the rack; - If the CPU is in RUN mode; - If the Fieldbus Master is in operation; - Network integrity between PROFIBUS Master and Head/Remote.	4
Off	Blinking 3x	Module without calibration	<ul style="list-style-type: none"> - The module is not calibrated; - There was an error with the calibration value. 	The module must return to the manufacturer.	3
Off	Blinking 1x	Missing or parameterization error	The module isn't parameterized.	Check: - If the module parameterization is correct; - Network integrity between PROFIBUS Master and Head/Remote; - Network integrity between PROFINET Controller and Head/Remote.	2
Off	Blinking 4x	Fatal hardware fault	Hardware fault.	The module must return to the manufacturer.	1 (Higher)

Table 11: Status of Symbols D and E

Notes:

Field net master: There are different field net solutions, using different nomenclatures to refer to the net master. Examples: Profibus Master, MODBUS Client, PROFINET Controller, etc.

Module without calibration: Only valid for modules that have calibration, typically analog modules. Modules that do not have calibration will never show such an indication through the symbols D and E.

9.2.2. 0, 1 and Numerical Characters

The meaning of the numerical characters can be different for specific modules. In case of analog modules, the numerical characters show the respective state of each output. When the numerical character is on the respective output is configured and enabled and if the numerical character is off the respective output is disabled. The relationship between the output number and its respective numerical character can be found on the following figure.

In the case of the NX6134 module, only the character 0 is connected. The following figure shows the relation between numerical characters and the respective outputs.

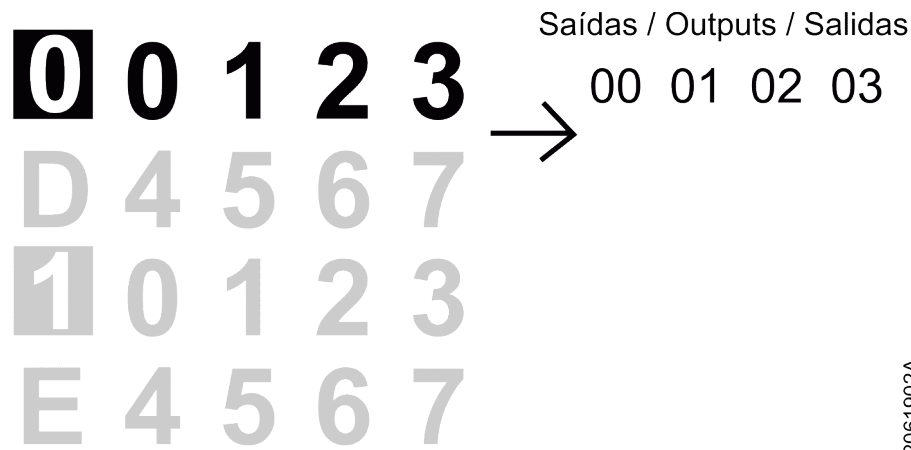

Figure 4: Display

9.3. Web Page with Complete Status and Diagnostics List

Another way to access diagnostics information on Nexto Series is via web pages. Nexto Series CPU's has an embedded web page server that provides all Nexto status and diagnostics information, which can be accessed using a simple browser.

More information about web page with complete status and diagnostics list can be found at User Manual of each respective CPU (listed at Nexto Series User Manual - MU214600).

9.4. Diagnostics Through Variables

All diagnostics in this module can be accessed through variables that can be handled by the user application or even forwarded to a supervisory system using a communication channel. There are two different ways to access diagnostics in the user application: using symbolic variables with AT directive or addressing memory. Altus recommends use symbolic variables for diagnostic accessing. The table below shows all available diagnostics for this module and their respective memory address, description, symbolic variable and string that will be shown on the CPU graphical display and web.

9.4.1. General Diagnostics

Direct Variable		Diagnostic Message	Symbolic Variable DG_NX6134.tDetailed.*	Description
Variable	Bit			
%QB(n)	0	OUTPUT 00 W/ DIAG	bActiveDiagnosticsOutput00	TRUE – Output 00 has active diagnostics
				FALSE – Output 00 doesn't have active diagnostics
	1	OUTPUT 01 W/ DIAG	bActiveDiagnosticsOutput01	TRUE – Output 01 has active diagnostics
		-		FALSE – Output 01 doesn't have active diagnostics
	2	OUTPUT 02 W/ DIAG	bActiveDiagnosticsOutput02	TRUE – Output 02 has active diagnostics
		-		FALSE – Output 02 doesn't have active diagnostics
	3	OUTPUT 03 W/ DIAG	bActiveDiagnosticsOutput03	TRUE – Output 03 has active diagnostics
		-		FALSE – Output 03 doesn't have active diagnostics
	4..7	Reserved		
	%QB(n+1)	0	MODULE W/ DIAGNOSTICS	bActiveDiagnostics
NO DIAG			FALSE – Module doesn't have active diagnostics	
1		MODULE W/ FATAL ERROR	bFatalError	TRUE – Fatal error
		-		FALSE – No fatal error
2		CONFIG. MISMATCH	bConfigMismatch	TRUE – Parameterization error
		-		FALSE – Parameterization ok
3		WATCHDOG ERROR	bWatchdogError	TRUE – Watchdog has been detected
		-		FALSE – No watchdog
4		OTD SWITCH ERROR	bOTDSwitchError	TRUE – Diagnostic switch failure
		-		FALSE – Diagnostic switch ok
5		CALIBRATION ERROR	bCalibrationError	TRUE – Module without calibration
		-		FALSE – Module calibrated
6		NO EXTERNAL SUPPLY	bNoExternalSupply	TRUE – No external voltage
		-		FALSE – Power supply ok
7		Reserved		

Table 12: General Diagnostics

9.4.2. Detailed Diagnostics

Direct Variable		Diagnostic Message	Symbolic Variable DG_NX6134.tDetailed.*	Description
Variable	Bit			
%QB(n+2+2*XX)	0..7	Reserved		
%QB(n+2+2*XX+1)	0	-	tAnalogOutput_XX.	TRUE – Output is not enabled
		-	bOutputNotEnable	FALSE – Output is enabled
	1	OPEN LOOP	tAnalogOutput_XX.	TRUE – Output is in open loop condition
		-	bOpenLoop	FALSE – Output is not in open loop condition
	2..7	Reserved		

Table 13: Detailed Diagnostics

Notes:

Open Loop: This diagnostic turns on when the output voltage of the channel exceeds 13.4 Vdc.

Direct Representation Variable: "n" is the address defined in the Module Diagnostics Start Address field in %Q on the module configuration screen - Module Parameters tab in MasterTool IEC XE, "XX" is the analog output channel.

Symbolic Variable: Some symbolic variables serve to access diagnostics. These diagnostics are stored into the addressing memory, then the AT directive is used to map the symbolic variables in the addressing memory. The directive AT is a reserved word in the MasterTool IEC XE, that uses this directive to declare the diagnostics automatically on symbolic variables. All symbolic variables declared automatically can be found inside of diagnostics object.

9.5. Hot Swap

This product supports hot swap. For further information about how to correctly perform a hot swap, consult Nexto Series User Manual - MU214600.

10. Manuals

For further technical details, configuration, installation and programming, the table below should be consulted.

The table below is only a guide of some relevant documents that can be useful during the use, maintenance, and programming of this product.

Code	Description	Language
CE114000	Nexto Series – Technical Characteristics	English
CT114000	Série Nexto – Características Técnicas	Portuguese
MU214600	Nexto Series User Manual	English
MU214000	Manual de Utilização Série Nexto	Portuguese
MU299609	MasterTool IEC XE User Manual	English
MU299048	Manual de Utilização MasterTool IEC XE	Portuguese
MP399609	MasterTool IEC XE Programming Manual	English
MP399048	Manual de Programação MasterTool IEC XE	Portuguese
MU214608	Nexto PROFIBUS-DP Head Utilization Manual	English
MU214108	Manual de Utilização da Cabeça PROFIBUS-DP Nexto	Portuguese

Table 14: Related Documents