

NEXTO

Jet



TAKE CONTROL OVER YOUR BUSINESS



MARKETS

VERSATILE AND HIGH PERFORMANCE, NEXTO JET HAS NEXTO SERIES' INNOVATIVE FEATURES FOR SMALL AND MEDIUM APPLICATIONS, BEING IDEAL FOR:

INFRASTRUCTURE | BUILDING AUTOMATION | WATER & WASTEWATER
MACHINE AUTOMATION | DISTRIBUTED INDUSTRIAL AUTOMATION

NEXTO SERIES

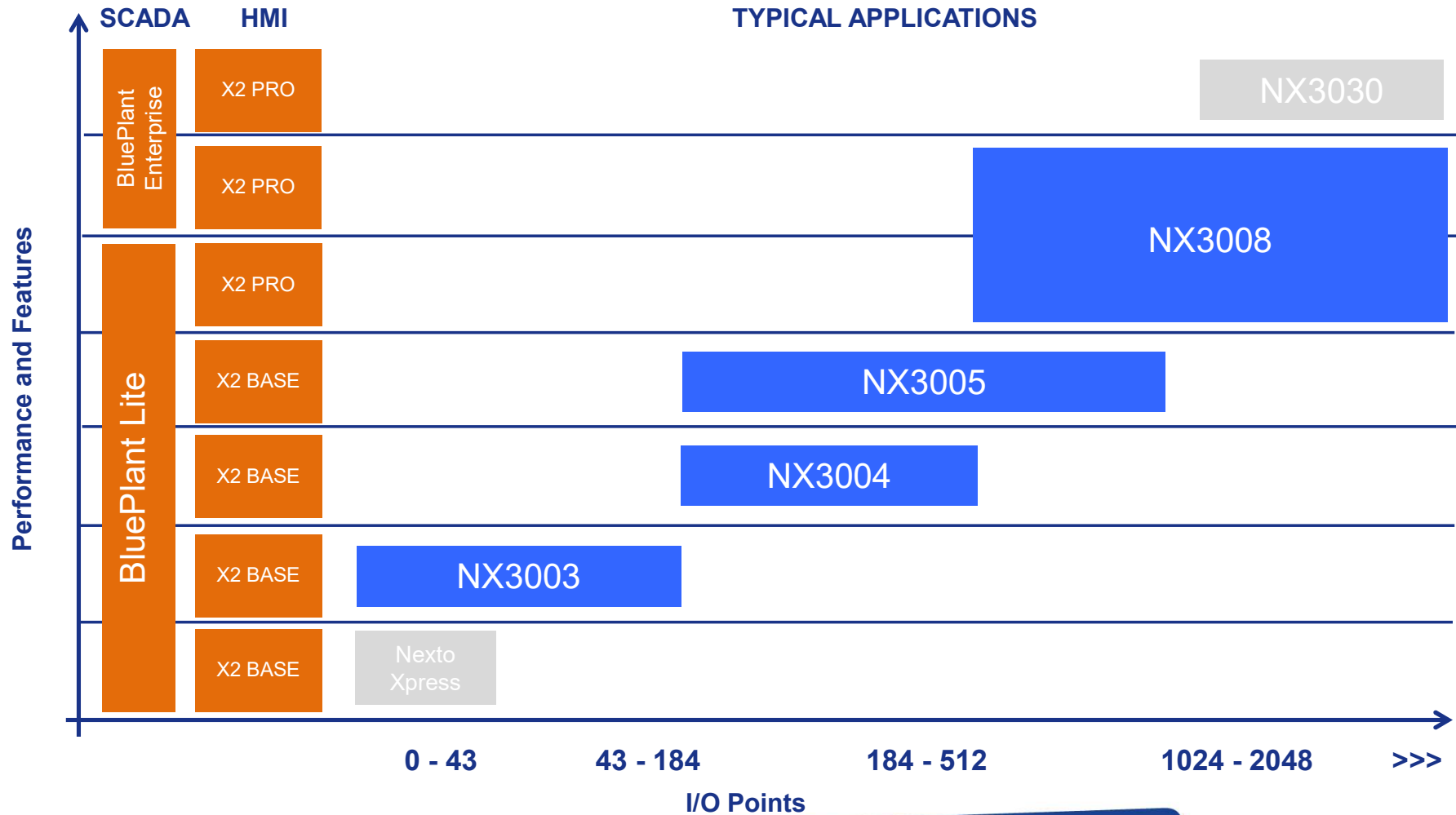

COMPACT APPLICATIONS

NEXTO JET



NEXTO JET

Features – I/O System

- Modular Architecture
- The CPUs, distributed I/Os and backplanes from Nexto Series can use Nexto Jet modules
- The available modules are:
 - 24Vdc Digital I/O
 - Analog tension & current I/O
 - Temperature analog input (RTD and TC)

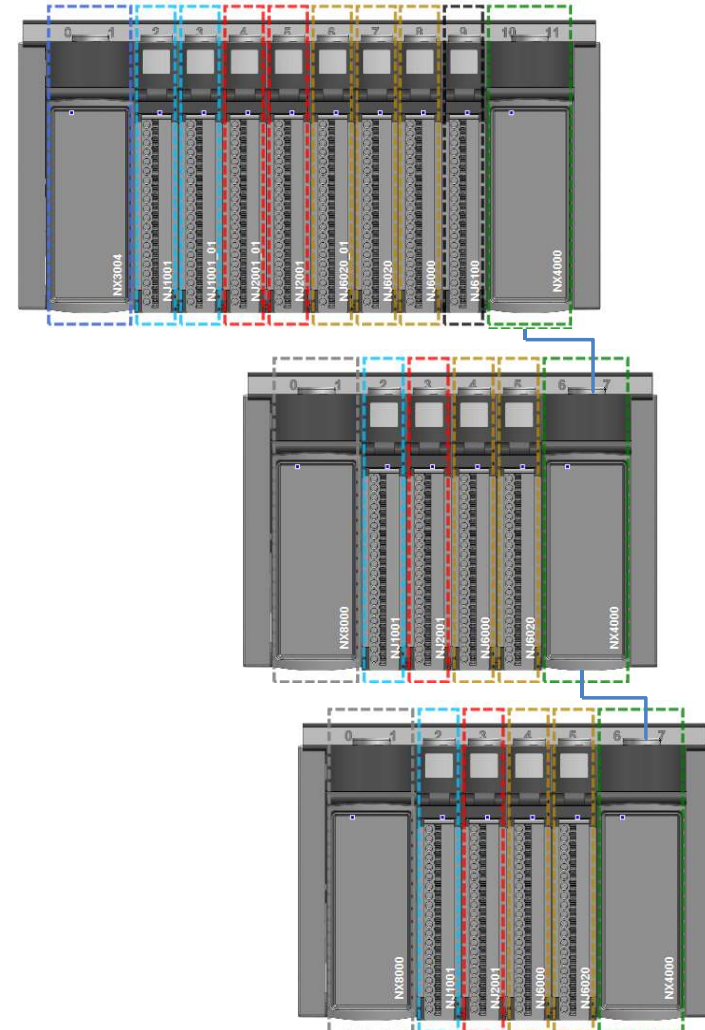

MAIN FEATURES

NEXTO JET

- The main differences from Nexto I/Os are:
 - **No** support for OTD diagnostics
 - **No** EPS functionality
 - **No** support for hot-swap
 - **No** relay output module
- The Nexto Jet I/O modules **cannot** be mixed with Nexto I/O modules in the same backplane
- The Nexto I/O and Nexto Jet modules **cannot** be mixed with the same CPU (for example, using expansion racks)
- Nexto Jet I/O modules are available **only** in 18mm width size

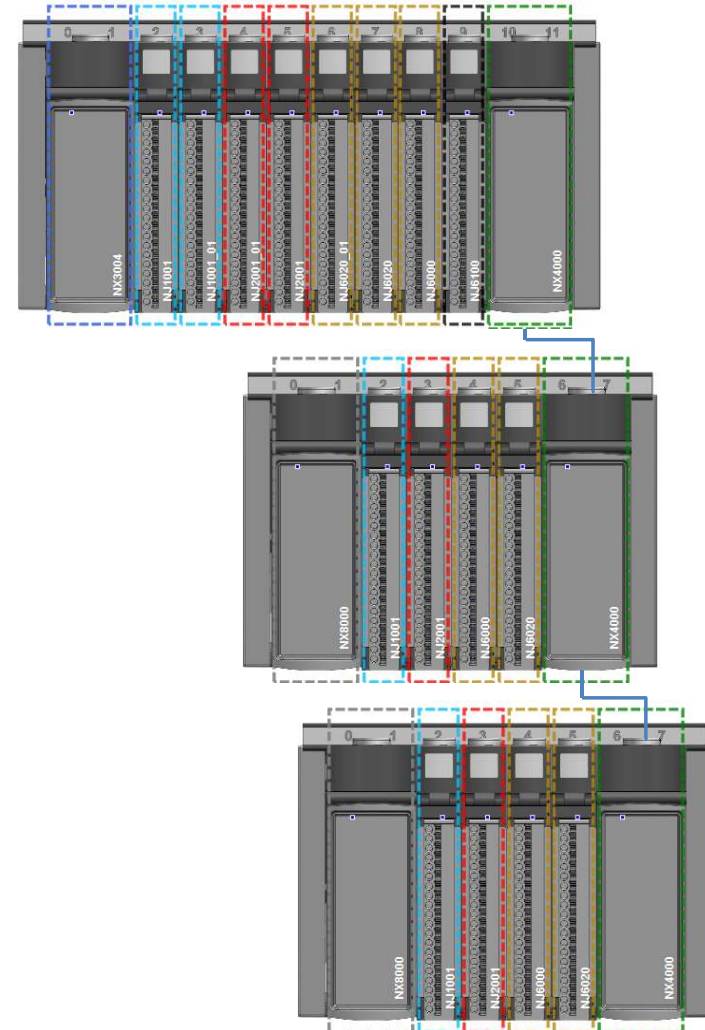

MAIN COMPONENTS

NEXTO JET

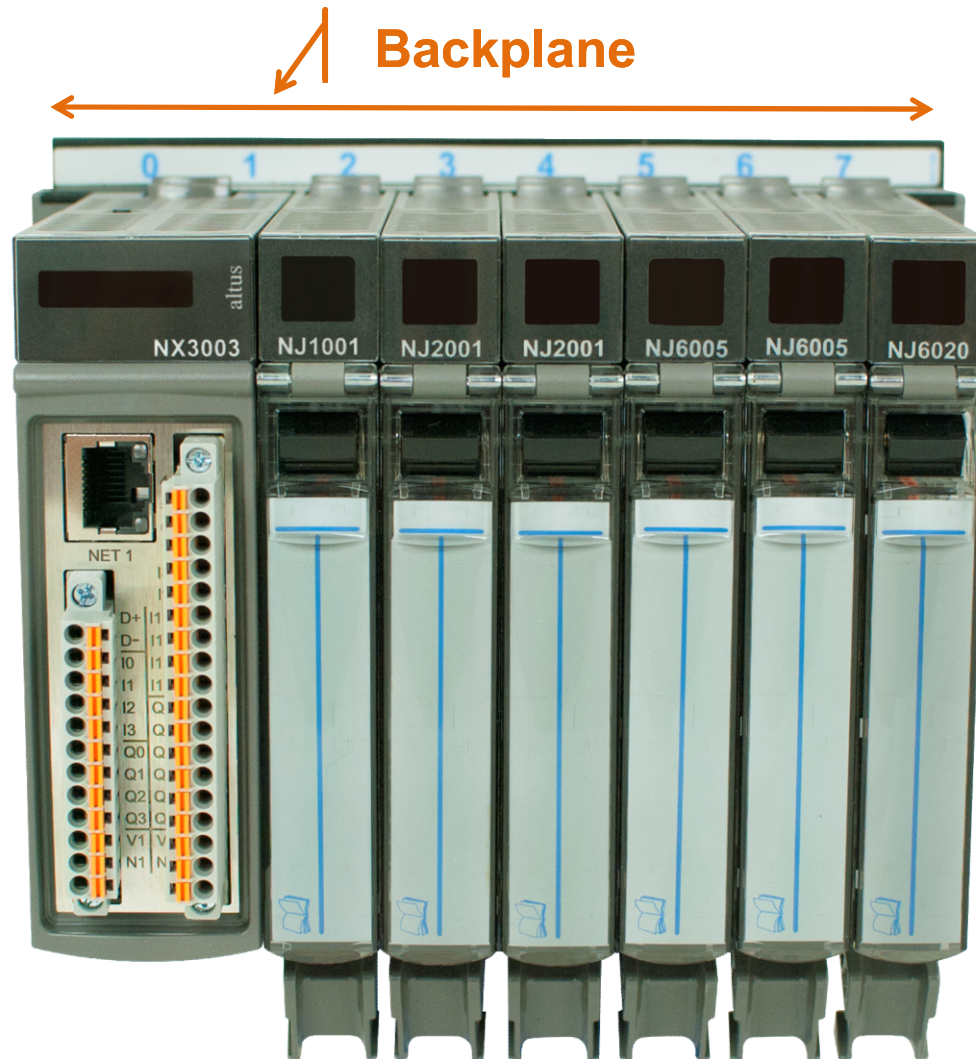

NEXTO SERIES



NX9020

- 2 slots
- Standalone applications without I/O modules
- CPUs NX3003, NX3004 e NX3005

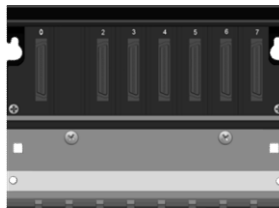

NX9010

- 8 slots (no hot-swap)
- Compact OEM applications
- NX3003, NX3004 and NX3005: CPU
- NX5110: PROFIBUS-DP Head
- No support for rack expansion
- Support for 18mm I/O modules only

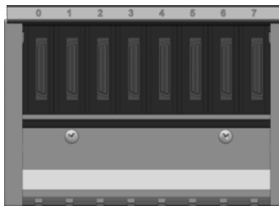

NX9000

- 8 slots (hot-swap)
- Compact applications

NEXTO SERIES

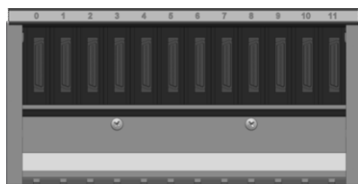

NX9001 - 12 slots

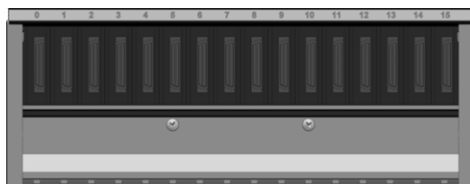

NX9002 - 16 slots



NX9003 - 24 slots

MAIN COMPONENTS

NEXTO JET

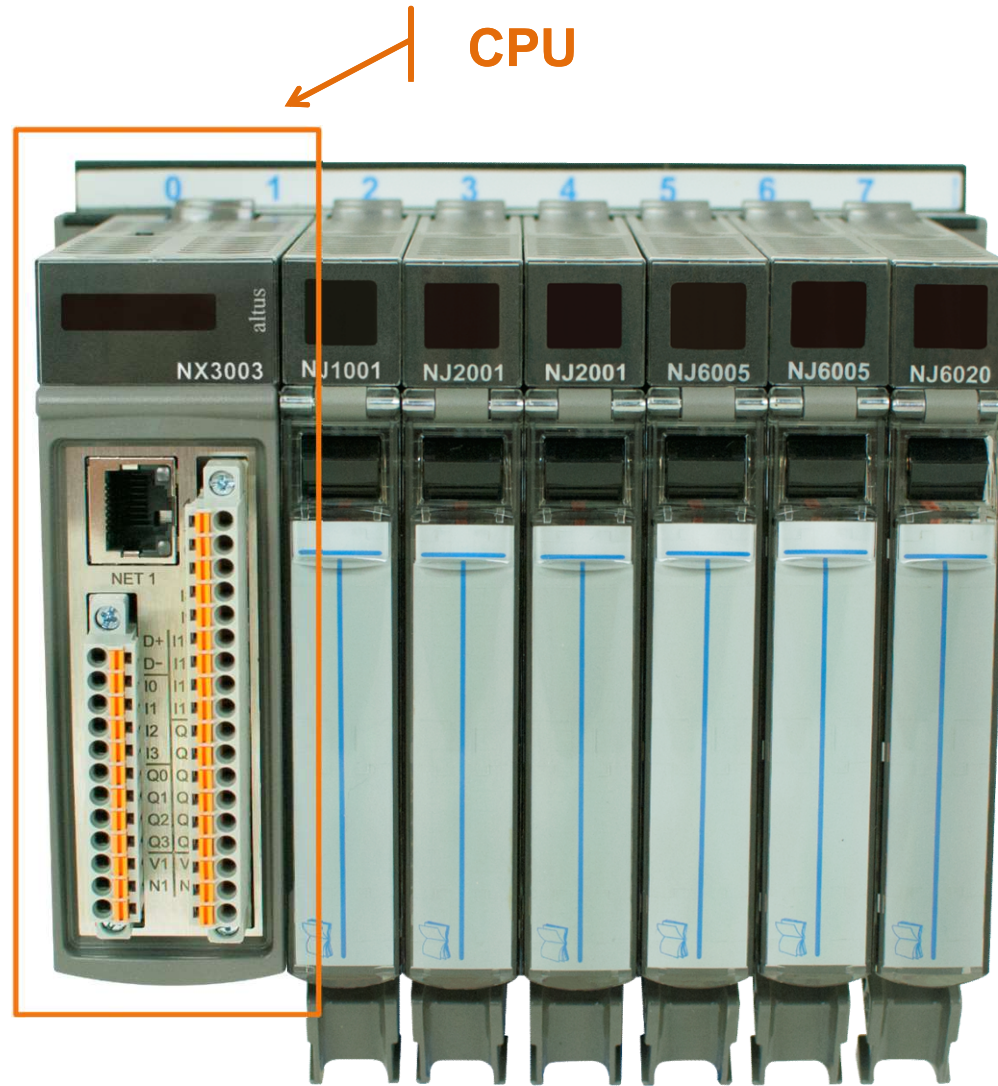

CPU NX3003

NEXTO JET SOLUTIONS

IDEAL CPU FOR SMALL APPLICATIONS WITH FEW I/O POINTS

- CPU with integrated power supply
- Supports up to 10 I/O modules
- 14 integrated digital inputs (4 fast inputs)
- 10 integrated digital outputs (4 fast outputs)
- One Ethernet port
- One serial port (MODBUS RTU / User)
- Support for MODBUS RTU, MODBUS TCP, MODBUS RTU/TCP, EtherNet/IP, SNTCP, SNMP, MQTT, OPC DA and OPC UA protocols



CPU NX3004

NEXTO JET SOLUTIONS

IDEAL SOLUTION FOR HIGH PERFORMANCE MACHINES CONTROL AND SMALL SIZED AUTOMATIONS

- CPU with integrated power supply, reducing space and cost on your application
- Use with up to 32 I/O modules
- Ethernet Port
- Allows rack expansion (with NX4000)
- Access to PROFIBUS remotes (with NX5001)
- Support for MODBUS RTU, MODBUS TCP, MODBUS RTU/TCP, EtherNet/IP, SNTP, SNMP, MQTT, OPC DA and OPC UA protocols



CPU NX3005

NEXTO JET SOLUTIONS

IDEAL SOLUTION FOR APPLICATIONS WITH EMBEDDED WEB SUPERVISION

- CPU with integrated power supply
- Supports up to 64 I/O modules
- One Ethernet port
- Supports one rack expansion (NX4000)
- Supports one PROFIBUS-DP field network (NX5001)
- One serial port (MODBUS RTU / User)
- Embedded Web development in the CPU
- Support for IEC 60870-5-104 Servidor, EtherNet/IP, WebServer, MODBUS RTU, MODBUS TCP, MODBUS RTU/TCP, SNMP, MQTT, OPC DA and OPC UA protocols



CPU NX3005

NEXTO JET SOLUTIONS

- REMOTE WEB ACCESS
- TELEMETRY
- WATER TREATMENT STATIONS

HTTP (Web Server)



SÉRIE NEXTO

- 1 GHz 64-bit ARM processor;
- 3 Ethernet interfaces, one of which is Gigabit and two of which can be configured to operate as PROFINET IO Controller, with support for closing the ring, both with MRP (Media Redundancy Protocol) acting as the ring manager (MRM - Media Redundancy Manager) in PROFINET networks, and with RSTP (Rapid Spanning Tree Protocol) in other protocols
- 1 isolated RS-485 serial interface
- 1 isolated CAN interface
- 1 microSD memory card for storage and mass memory
- 1 USB interface for storage, mass memory, USB-Serial converter, wireless and 4G modem
- Integrated power supply
- On-board HTTP server for diagnostics
- Web page development for user application (Webvisu)
- Extended operating temperature of -20 to 60°C



NEXTO SERIES

	NX3003	NX3004	NX3005	NX3008	NX3010	NX3020	NX3030
Program Memory	3 MB	3 MB	6 MB	32 MB	4 MB	6 MB	8 MB
Source-Code Memory	32 MB	32 MB	40 MB	256 MB	40 MB	80 MB	120 MB
Master PROFIBUS-DP Fieldbus	-	1	1	4	1	4	4
Ethernet Interfaces	1	1	2	3	1	4	8
Redundancy (Fieldbus/Ethernet)	-	-	-	Yes	-	Yes	Yes
Sequence of Events (SOE)	-	-	-	-	-	Yes	Yes
Memory Card Support	-	-	-	Yes	Yes	Yes	Yes
Supported Rack Expansions	-	1	4	Yes	8	24	24
Maximum Number of I/O Modules	10	32	64	128	128	128	128
Embedded Digital Inputs	14	-	-	-	-	-	-
Embedded Digital Outputs	10	-	-	-	-	-	-

NEXTO JET

NX5101 – MODBUS TCP HEAD WITHOUT HOT-SWAP

- Compatible with any MODBUS TCP client device
- Integrated power supply
- Support for up to 22 I/O modules in the backplane
- Configuration via the same MasterTool IEC XE used for configuring Nexto Series CPUs



NEXTO JET

NX5110 – PROFIBUS-DP HEAD

- Compatible with any PROFIBUS-DP master equipment, following the EN 50170 standard
- Integrated power supply
- Support for up to 22 I/O modules on the bus
- Automatic configuration and parameterization of all modules via PROFIBUS-DP Class 1 master



MAIN COMPONENTS

NEXTO JET

Digital and Analog I/O

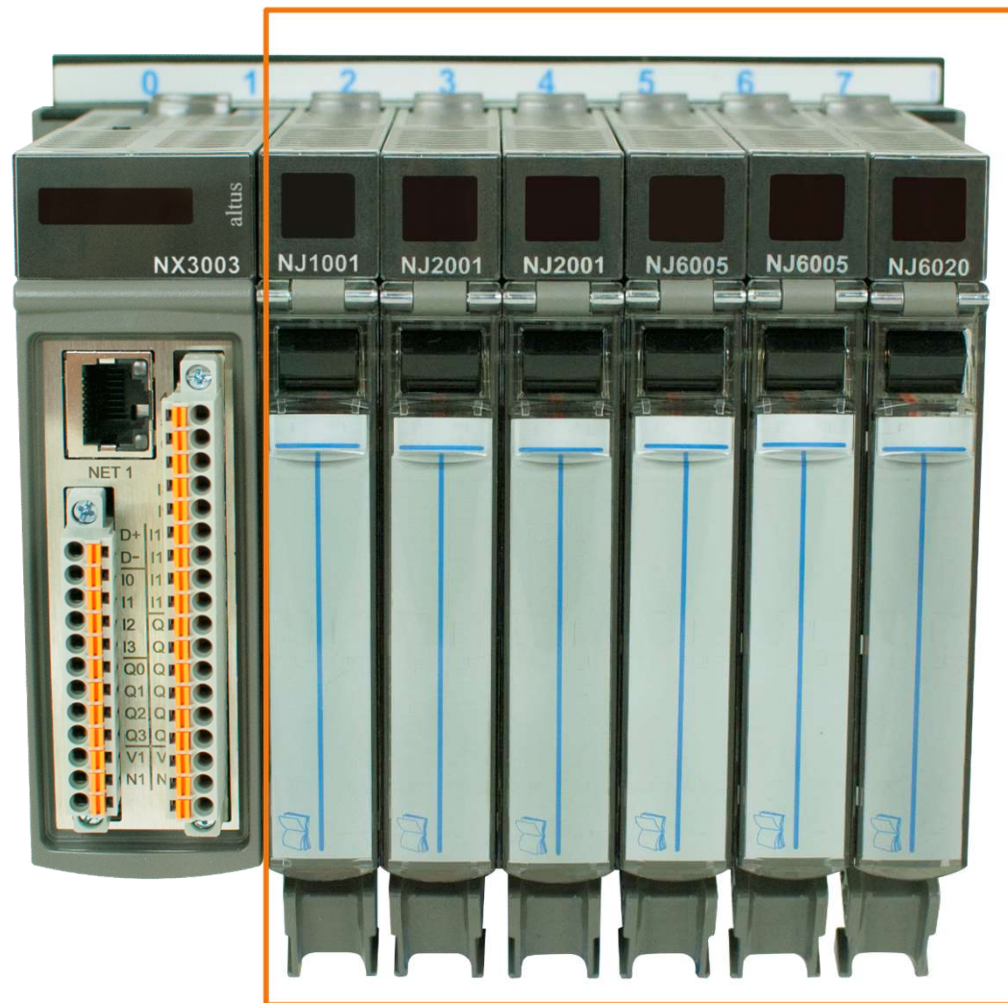

I/O MODULES

NEXTO JET

OPTIMIZING YOUR PANELS - 18 MM MODULE

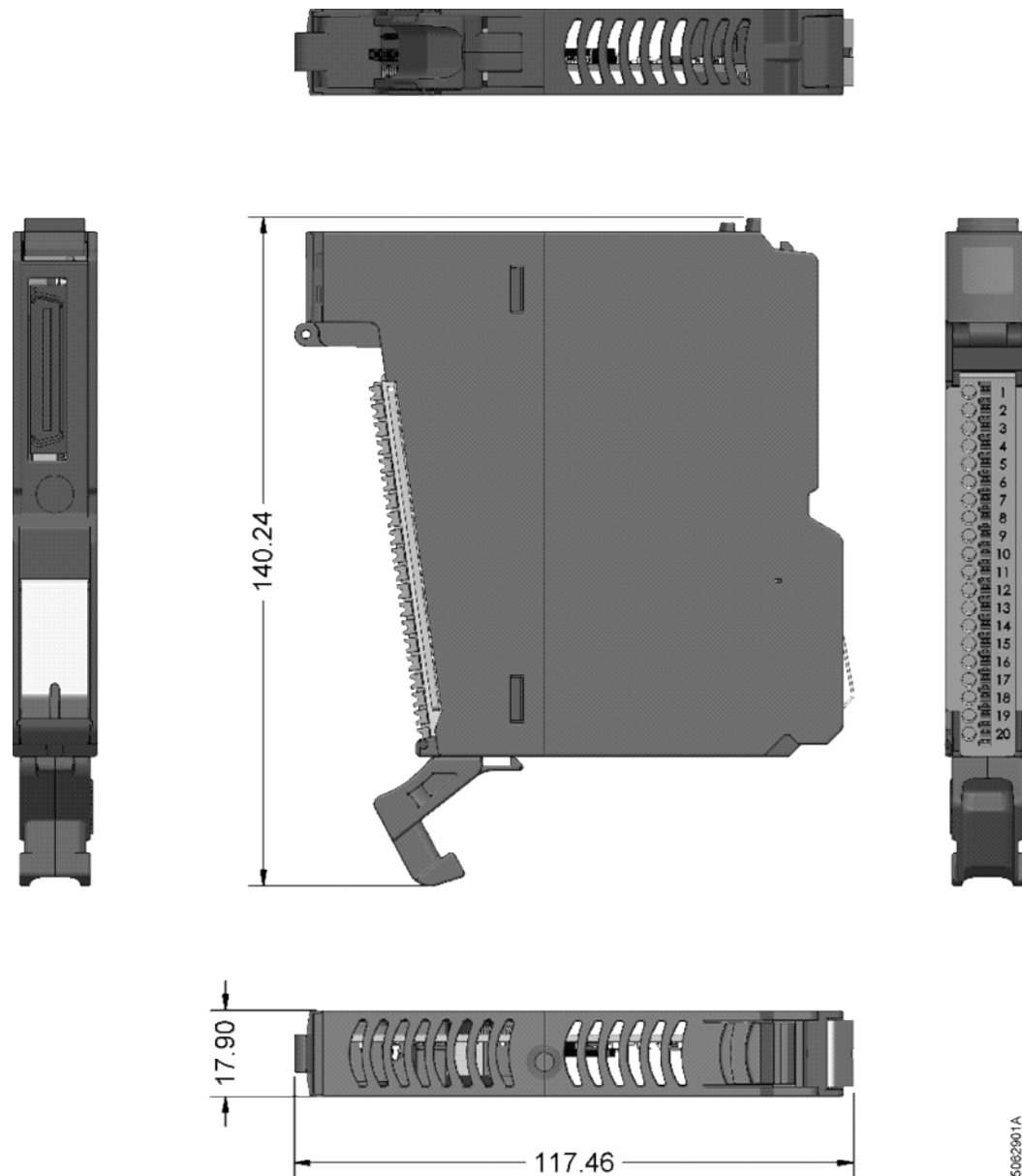

NEXTO JET

- **NJ1001**
 - 16 Digital Inputs Module (24 Vdc)
 - Optoisolated inputs (sink/source)
- **NJ1005**
 - 8 Digital Inputs and 8 Transistor Digital Outputs (24 Vdc)



NEXTO JET

■ NJ2001

- 16 Transistor Digital Outputs module
- Outputs grouped into 2 groups, isolated between each other and logic
- Maximum current per output – 1.5A @ 30Vdc
- Maximum current per group – 6A @ 30 Vdc



NEXTO JET

■ NJ6000

- 8 Tension/Current 16 bits Analog Inputs module
- Inputs isolated from logic
- Internal protection for 24Vdc
- Selectable scales via software:
 - 0 to 10 V
 - -5V to +5V
 - -10 V to +10 V
 - 0 to 20 mA
 - 4 to 20 mA

■ NJ6001

- 6 Tension/Current 12 bits Analog Inputs module
- Inputs isolated from logic
- Internal protection for 24Vdc
 - 0 to 10 V
 - 0 to 20 mA



NEXTO JET

■ NJ6005

- 6 Tension/Current 12 bits Analog Outputs and 4 Tension/Current 12 bits Analog Inputs module
- Inputs isolated from logic
- Outputs isolated from logic
- Selectable scales via software:
 - 0 to 10 V
 - 0 to 20 mA



NEXTO JET

■ NJ6100

- 4 Tension/Current 16 bits Analog Outputs module
- Outputs isolated from logic
- Scales selectable via software:
 - 0 to 10 V
 - -10 V to +10 V
 - 0 to 20 mA
 - 4 to 20 mA

■ NJ6101

- 4 Tension/Current 12 bits Analog Outputs module
- Outputs isolated from logic
- Scales selectable via software:
 - 0 to 10 V
 - 0 to 20 mA



NEXTO JET

■ NJ6010

- 8 thermocouple analog inputs module
- Inputs isolated from logic
- Support for thermocouples type:
 - J, K, B, E, T, R, S e N
- Individual configuration per input
- 24 bits A/D Converter Resolution

■ NJ6011

- 4 Thermocouple Analog Inputs module
- Has the same features as NJ6010



NEXTO JET

- **NJ6020**
 - 8 RTD Analog Inputs module
 - Inputs isolated from logic
 - Supported RTD sensors:
 - Pt100, Pt200, Pt500, Pt1000
 - Ni100, Ni120, Ni200, Ni500, Ni1000
 - Support for resistance ranges:
 - 0 Ω to 400 Ω , 0 Ω to 4000 Ω , 0 Ω to 10000 Ω
 - Individual configuration per input
 - 24 bits A/D Converter Resolution



PROGRAMMING ENVIRONMENT

MASTERTOOL IEC XE



- An easy-to-use software environment for all your automation needs
- Friendly user interface
- Control platform with a modern programming environment
- 6 programming languages
- Online programming

MASTERTOOL IEC XE

ALLOWS QUICK AND SMART SYSTEM CONFIGURATION:

- Advanced editing resources, integrating communication protocols and field backplane configuration on the same environment
- Graphical configuration interface (including remote backplanes)
- Auto-complete and quick help files resources integrated

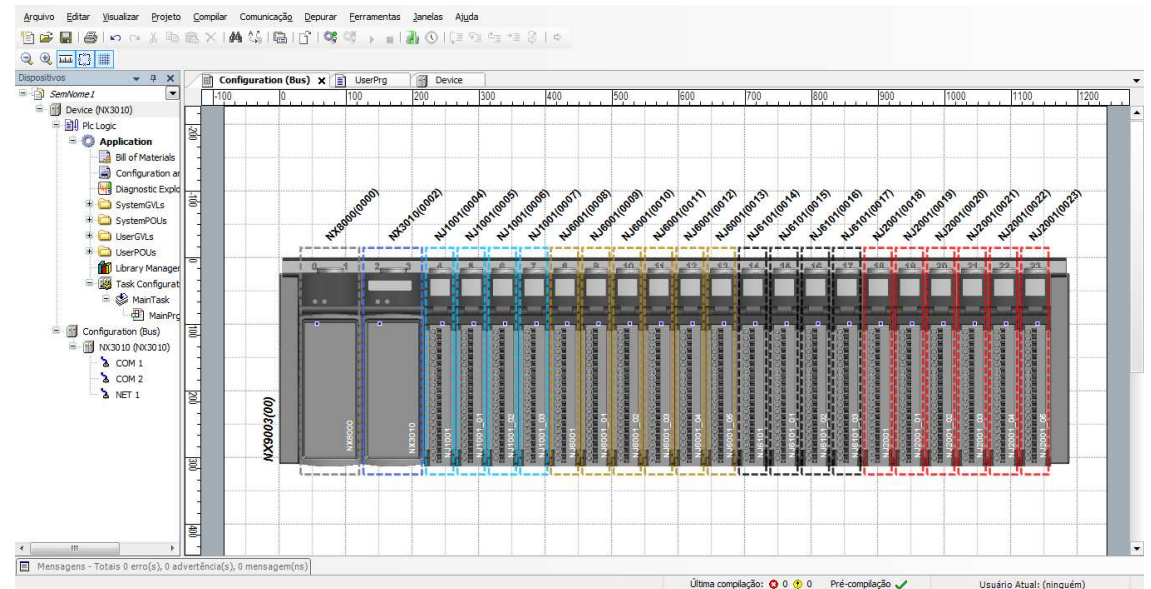

MASTERTOOL IEC XE

- Object-oriented programming
- Simulation tool, without the need of a connected controller
- Printing of application documents, such as BOM, programs (POU), parameters, tags and descriptions
- Docking View: MasterTool IEC XE environment's customization by the user

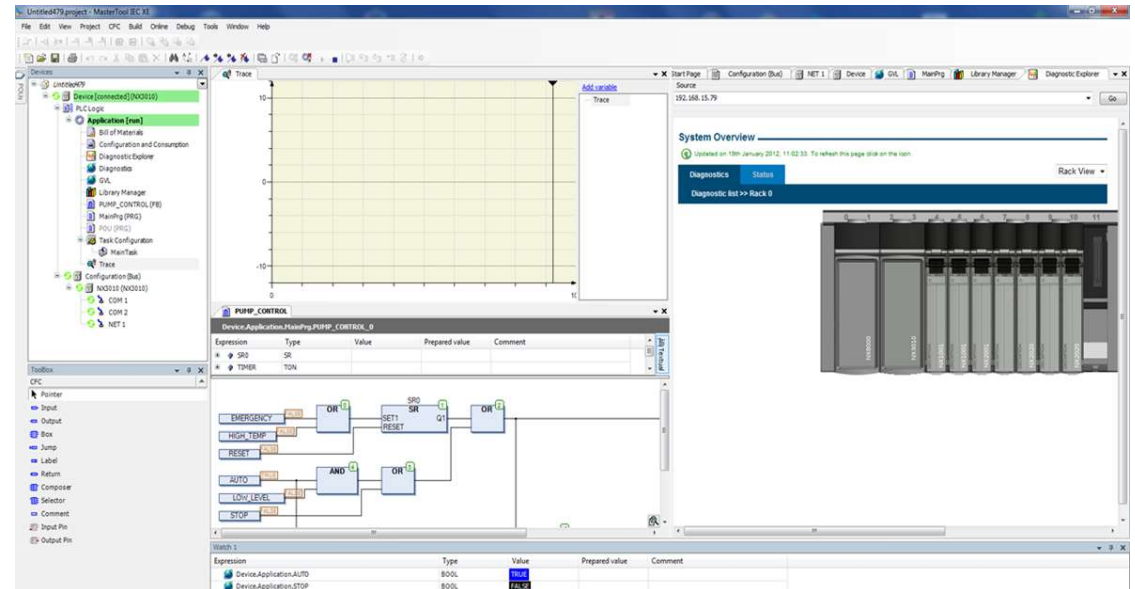

MASTERTOOL IEC XE

- Application's offline simulation
- Application's online debugging
- Monitoring of:
 - I/O variables
 - Symbolic variables
 - System diagnostics
 - Modules Diagnostics
- Use of breakpoint and step-by-step execution
- Simulation of communication with SCADA and HMI using OPC DA

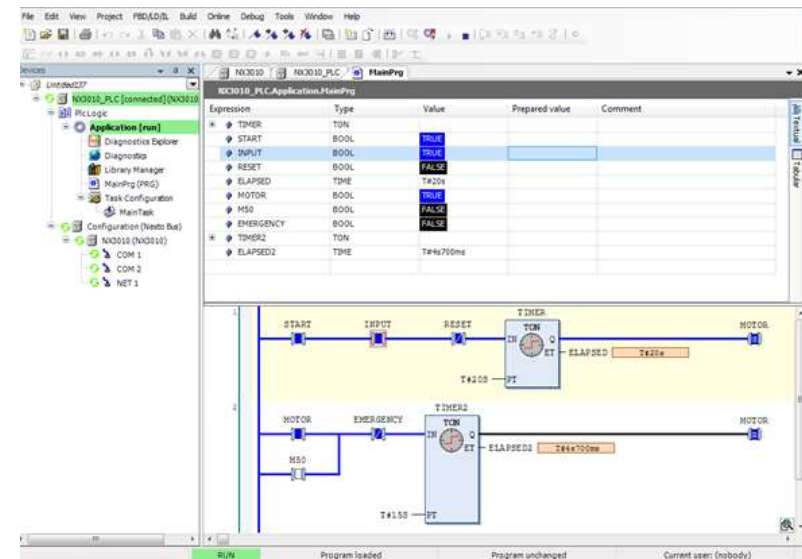
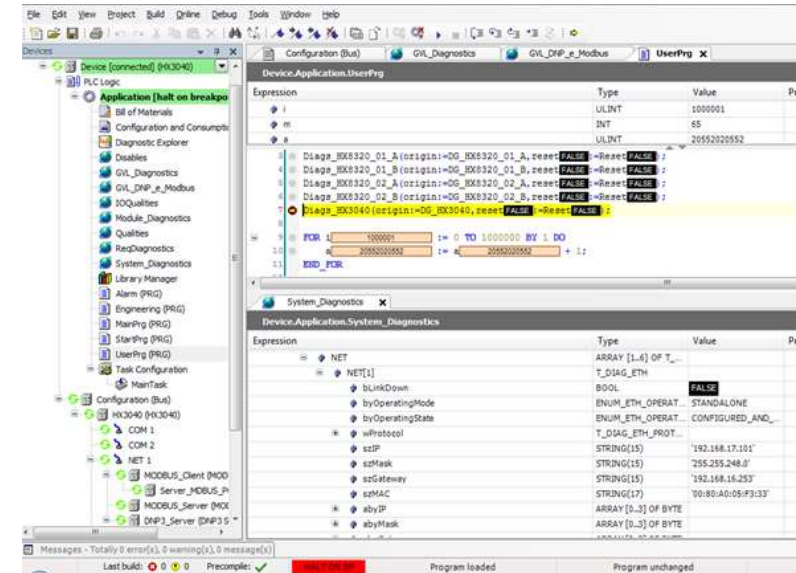

MASTERTOOL IEC XE

IEC 61131-3 – PROGRAMMING LANGUAGES

- Structured Text (ST)
- Sequential Function Chart (SFC)
- Function Block Diagram (FBD)
- Ladder Diagram (LD)
- Instruction List (IL)
- Continuous Function Chart (CFC)
- Support for different languages on the same project

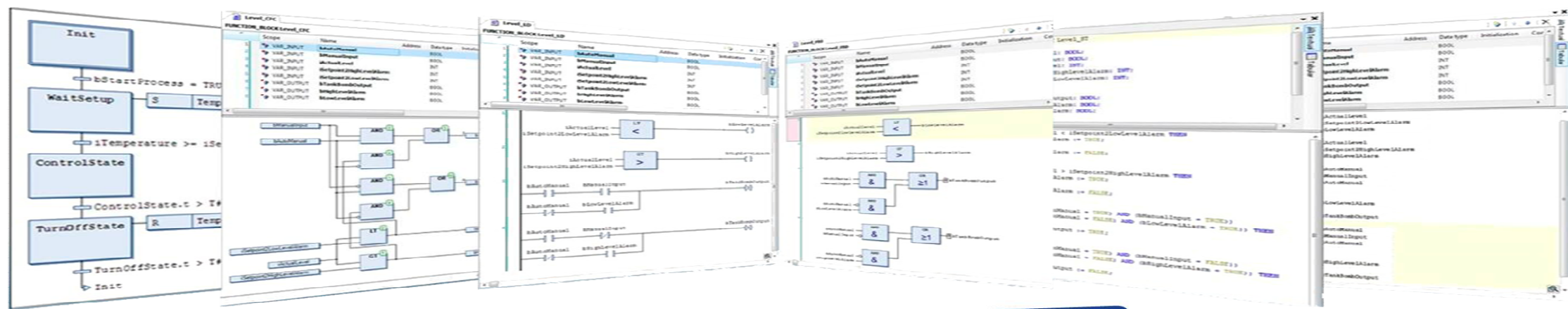

MASTERTOOL IEC XE

Features	Lite	Basic	Pro	Adv
Free Version	YES	NO	NO	NO
CPUs	XPRESS NX3003 NX3004 NX3005 NX3010	XPRESS NX3003 NX3004 NX3005 NX3010 NX3020	ALL	ALL
Rack Expansion	NO	YES	YES	YES
Additional Ethernet Modules	NO	YES	YES	YES
PROFIBUS DP Interfaces	NO	NX3004 NX3005 NX3010 NX3020	NX3004 NX3005 NX3010 NX3020	NX3004 NX3005 NX3010 NX3020
Max. Number of I/O points	320	2048	NO LIMIT	NO LIMIT

NEXTO SERIES

■ Technical Features

- All modules have their own technical documentation with the technical features available in Portuguese, English and Spanish

■ User Manuals

- Extensive technical literature available in Portuguese and English
- Over 1,000 pages, covering:
 - Nexto Series User Manual
 - MasterTool IEC XE User Manual
 - IEC 61131-3 Programming Manual
 - Nexto CPUs User Manual
 - PROFIBUS-DP Master User Manual



 @altus.sa    altussa



KNOW OUR PRODUCTS
AND SOLUTIONS

www.altus.com.br

altus

The information contained in this material is property of Altus Sistemas de Automação S.A. and can be modified with no previous notice.