

## 1. Product Description

Automation of power applications is characterized by the use of rugged and reliable equipment and devices with high technology, capability to operate in hostile environments, where there are significant levels of electromagnetic interference and higher operating temperatures. This is the reality of applications in hydropower plants, power substations and wind farms, among others.

In this context, the Hadron Xtorm Series is an innovative Remote Terminal Unit (RTU), perfect for applications in electricity generation, transmission, and distribution. The Series has an ideal set of features with high performance and facilities for the various stages in the life cycle of an application, to reduce engineering, installation, and commissioning costs and minimize downtime and system maintenance when in operation. With intuitive and user-friendly interfaces, precise and intelligent diagnostics, a modern and robust design, and several innovative features, Hadron Xtorm exceeds the requirements of applications in this market.

The Series has an intelligent and versatile architecture, offering modularity in input and output (I/O) points, redundancy options, hot-swapping of modules, high-speed communication protocols such as IEC 61850 and DNP3, implementation of logic in compliance with the IEC 61131-3 standard and time synchronization.

HX8300 and HX8320 modules supplies up to 60 W of power to the other modules of the Hadron Xtorm series through the racks. The modules have 24 Vdc (HX8300) or 125 Vdc (HX8320) isolated input with an internal protection fuse accessible from its front panel. Due to its internal high efficiency switched power supply, the modules offers high power output, low noise and immunity to electromagnetic interference (EMC/EMI). In addition, this module has the bus expansion feature, which allows the connection of the main rack with remote input and output racks through two RJ45 ports located on the module front panel.



Its main features are:

- Switched power supply
- Redundancy operating capacity
- 60 W output power
- 24 Vdc (HX8300) or 125 Vdc (HX8320) input voltage
- Internal fuse protection
- Protection against polarity reversal
- Voltage surge protection
- Integrated bus expansion function
- Fan-less design (no moving parts inside)
- Module diagnostics via graphical display and LEDs
- Indication of operation through NO dry contact relay

## 2. Ordering Information

### 2.1. Included Items

The product package contains the following items:

- HX8300 or HX8320 Module
- HX9401 06 pin terminal block

## 2.2. Product Code

The following codes should be used to purchase the product:

Code	Description
HX8300	60 W 24 Vdc Redundant Power Supply
HX8320	60 W 125 Vdc Redundant Power Supply

Table 1: Product Code

## 3. Related Products

The following products must be purchased separately when necessary:

Code	Description
NX9202	RJ45-RJ45 2 m Cable
NX9205	RJ45-RJ45 5 m Cable
NX9210	RJ45-RJ45 10 m Cable
HX9401	06-terminal Connector

Table 2: Related Products

**Note:**

**NX9202, NX9205 e NX9210:** CAT5 Ethernet cable, shielded, twisted pair, RJ45 male connectors on both ends, supports temperature of -5 °c to 70 °c, to be used in Ethernet networks, with length of 2, 5 and 10 m, respectively.

## 4. Innovative Features

Hadron Xtorm Series brings to the user several innovations in utilization, supervision and system maintenance. These features were developed focusing a new concept in automation of hydropower plants, substations and other applications of the segment. The list below shows some new features that the user will find in Hadron Xtorm Series:





**One Touch Diag:** One Touch Diag is an exclusive feature that Hadron Xtorm Series brings to PLCs. With this new concept, the user can check diagnostic information of any module present in the system directly on CPU's graphic display with one single press in the diagnostic switch of the respective module. OTD is a powerful diagnostic tool that can be used offline (without supervisor or programmer), reducing maintenance and commissioning times.

**ETD – Electronic Tag on Display:** Another exclusive feature that Hadron Xtorm Series brings to PLCs is the Electronic Tag on Display. This new functionality brings the process of checking the tag names of any I/O pin or module used in the system directly to the CPU's graphic display. Along with this information, the user can check the description, as well. This feature is extremely useful during maintenance and troubleshooting procedures.

## 5. Product Features

### 5.1. General Features

	HX8300	HX8320
<b>Nominal input voltage</b>	24 Vdc	125 Vdc
<b>Maximum output power dissipated</b>	60 W	
<b>Maximum output current</b>	12 A	
<b>Input voltage range</b>	19.2 Vdc to 30 Vdc	100 to 150 Vdc
<b>Nominal input current</b>	4,2 A @ 19.2 Vdc	850 mA @ 100 Vdc
<b>Typical efficiency</b>	76% @ 19.2 Vdc	82% @ 100 Vdc
<b>Maximum input voltage interruption time</b>	10ms @ 19.2 Vdc	10 ms @ 100 Vdc
<b>Inrush current</b>	12A @ 30 Vdc	5 A @ 125 Vdc
<b>Protection fuse</b>	5A	3A
<b>Redundancy support</b>	Yes	
<b>Hot swap support</b>	Yes	
<b>One Touch Diag (OTD)</b>	Yes	
<b>Protections</b>	Protection against polarity reversal Input short circuit protection with internal fuse Input protection against voltages lower than the minimum with auto-recovery	
<b>Isolation</b>		
<b>Input to output</b>	2500 Vac / 1 minute	
<b>Inputs to protective earth</b> 	2500 Vac / 1 minute	
<b>Input to functional earth</b> 	2500 Vac / 1 minute	
<b>Status indication and diagnostics</b>	Graphical display LEDs Auxiliary relay	
<b>Signaling relay</b>	Resistive Load: 5 A @ 24 Vdc 0,8 A @ 48 Vdc 0,7 A @ 60 Vdc 0,3 A @ 125 Vdc 0,2 A @ 240 Vdc 5 A @ 250 Vac Inductive Load: 1.5 A @ 24 Vdc (L/R 40 ms) 0.3 A @ 125 Vdc (L/R 40 ms)	
<b>Wire gauge</b>	2.5 mm <sup>2</sup>	
<b>IP level</b>	IP 20	
<b>Operating temperature</b>	-5 to 70 °C	
<b>Storage temperature</b>	-20 to 85 °C	
<b>Relative humidity</b>	5 to 96%, non-condensing	
<b>Conformal coating</b>	Yes	
<b>Module dimensions (W x H x D)</b>	38.0 x 235.3 x 189.1 mm	
<b>Package dimensions (W x H x D)</b>	55.0 x 308.0 x 266.0 mm	

	HX8300	HX8320
<b>Net weight</b>		1200 g
<b>Gross weight</b>		1500 g

Table 3: Product Features

**Notes:**

**Conformal coating:** Conformal coating protects the internal parts of the product from moisture, dust and other harsh elements to electronic circuits.

**One Touch Diag (OTD):** This option is available only when the module is in operating mode.

**5.2. Standards and Certifications**

<b>Standards and Certifications</b>	
<b>IEC</b>	61131-2: Industrial-process measurement and control - Programmable controllers - Part 2: Equipment requirements and tests
<b>CE</b>	2014/30/EU (EMC) 2014/35/EU (LVD) 2011/65/EU and 2015/863/EU (ROHS)
<b>UK CA</b>	S.I. 2016 No. 1091 (EMC) S.I. 2016 No. 1101 (Safety) S.I. 2012 No. 1101 (ROHS)
<b>EAC</b>	TR 004/2011 (LVD) CU TR 020/2011 (EMC)

Table 4: Standards and Certifications

### 5.3. Compatibility with Other Products

The module HX8300 is compatible only with MasterTool Xtorm version 1.10 or higher.

### 5.4. Bus Expansion Features

	HX8300 and HX8320
<b>Ports</b>	2
<b>Connectors</b>	RJ45 (shielded female)
<b>Bus expansion support with loopback (cabling redundancy)</b>	Yes
<b>Maximum number of expansion racks</b>	15 racks
<b>Maximum number of I/O modules</b>	80
<b>Maximum cable length</b>	100 m
<b>Cable type</b>	UTP or ScTP, category 5
<b>Baud rate</b>	Automatic
<b>Physical layer</b>	10/100BASE-T
<b>Isolation</b>	
<b>IN to logic</b>	1500 Vac / 1 minute
<b>IN to protective earth</b> Ⓧ	1500 Vac / 1 minute
<b>OUT to logic</b>	1500 Vac / 1 minute
<b>OUT to protective earth</b> Ⓧ	1500 Vac / 1 minute

Table 5: Bus Expansion Features

**Notes:**

**Time sync to event log:** Through the expansion bus function, it is possible to retransmit the CPU time synchronism signal to the digital input modules localized in the remote racks, allowing 1 ms resolution for the event log.

**Logic:** : Logic is the name of the internal interfaces as memories, processor and rack interfaces.

### 5.5. Power Supply Redundancy

The Hadron Xtorm series supports redundancy of power supplies installed in the same rack. When an error occurs with any of these power supplies, the second one assumes the total system load. This means that critical processes are not affected by hardware failures in the control system. The result is increased availability and reliability of the system, minimizing downtime and/or stop.

Further information about configuration and use of power supply redundancy features are found in the Hadron Xtorm User Manual – MU223100.

The figure below shows an example of a power supply redundancy topology.



Figure 1: Power Supply Redundancy

**Note:**

**Power Supply redundancy support:** In this case the redundant power supply needs to be connected in the in the rack positions 0 and 1.

## 5.6. System Configurations

The suggested configurations for the HX8320 module are shown below. The same configurations are valid also for HX8300 module.

### 5.6.1. Configuration A: Bus Expansion without Loopback

This architecture is based on a main rack (where the CPU is located) and remote racks. The communication between the local and remote racks is made through the extension ports, located on the front panel of the the HX8320 module. Each remote rack requires its own power supply module. The HX8320 module has two RJ45 ports, one being used for the input data and the other one for the output data.

In this application example, only the output port of the local HX8320 module is connected, leaving the input data port opened. On the other hand, in the last remote rack, is the output data port that stays open. The intermediate remote racks present both connected ports: a port connected to the previous rack and the other one to the next rack. Each HX8320 module contains two keys to select the rack address, which must be unique.

This architecture is designed for medium and large applications with high number of I/O points.

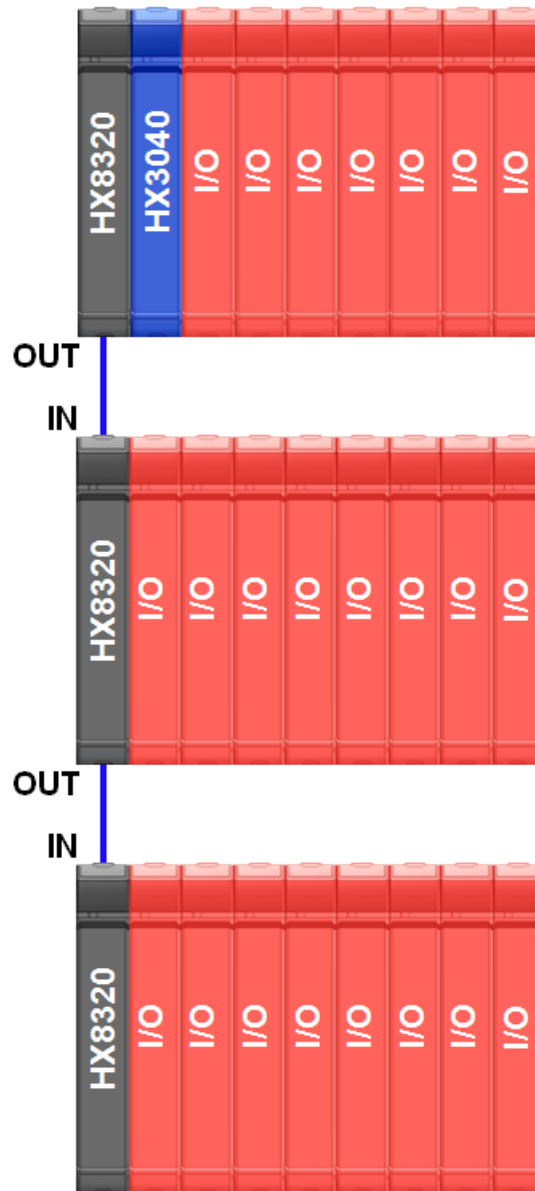

Figure 2: Bus Expansion without Loopback

**5.6.2. Configuration B: Bus Expansion with Loopback**

In the same way, as the previous one, this architecture is based on a local rack (where the CPU is located) and remote racks. The communication between the local and remote racks is made through the extension ports, located in the HX8320 module. The only difference compared to the previous architecture, is that the output data port of the last remote rack is connected to the main rack input data port.

This architecture allows the system to maintain access to remote racks information even in the event of a failure in the extension cables. The CPU detects the simple failure in one of the cables and redirects internal data paths to support this failure. In this case, will also be generated a diagnostic alarm for the user. This feature has advantages in the case of cables maintenance with the system energized, in addition to increasing system availability. The figure below illustrates this architecture.

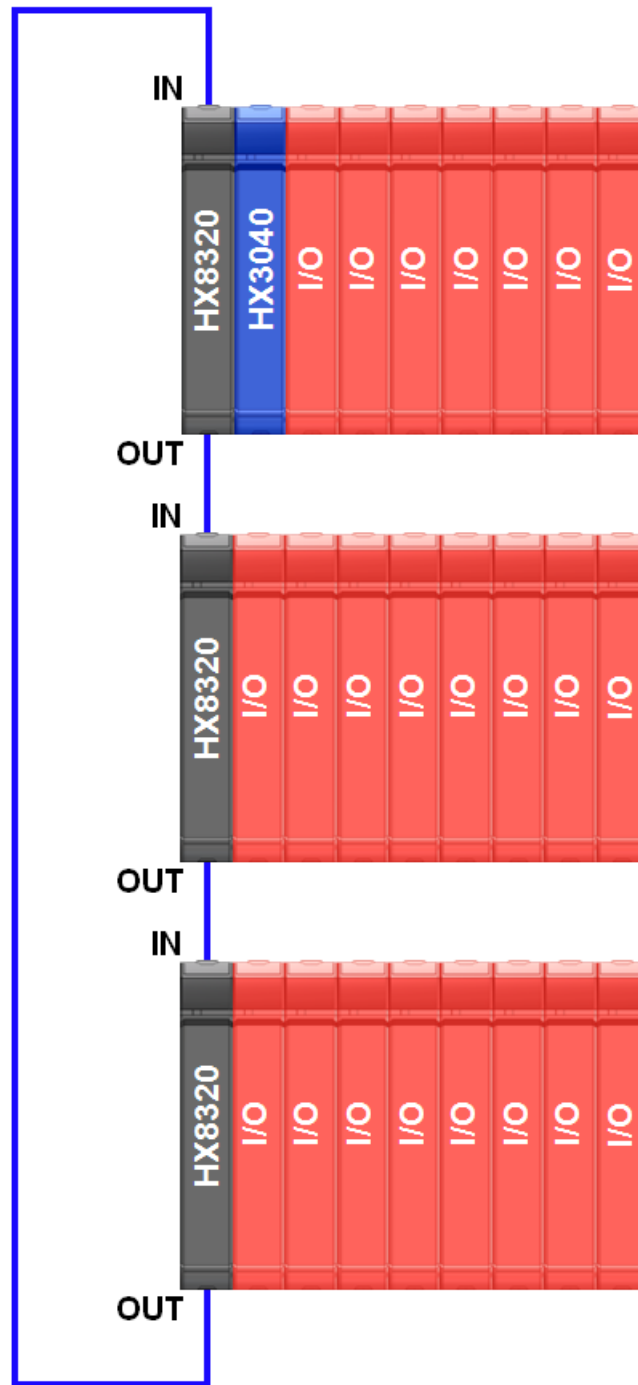

Figure 3: Bus Expansion with Loopback

**5.6.3. Configuration C: Power Supply and Bus Expansion Redundancy with Loopback**

This architecture is based on the use of two HX8320 modules per rack. Relying on two bus expansion modules, the system features a high availability as it supports failure in bus expansion cables or in the HX8320 module itself.

Similarly to the previous architecture, this one is intended for systems where the maintenance is critical and the system needs to be available for extended periods. In this architecture, the racks must be mounted in accordance with the diagram below, with HX8320 modules located side by side at rack position 0 and 1.

Note that there are expansion bus modules with unused ports, which should be left disconnected.



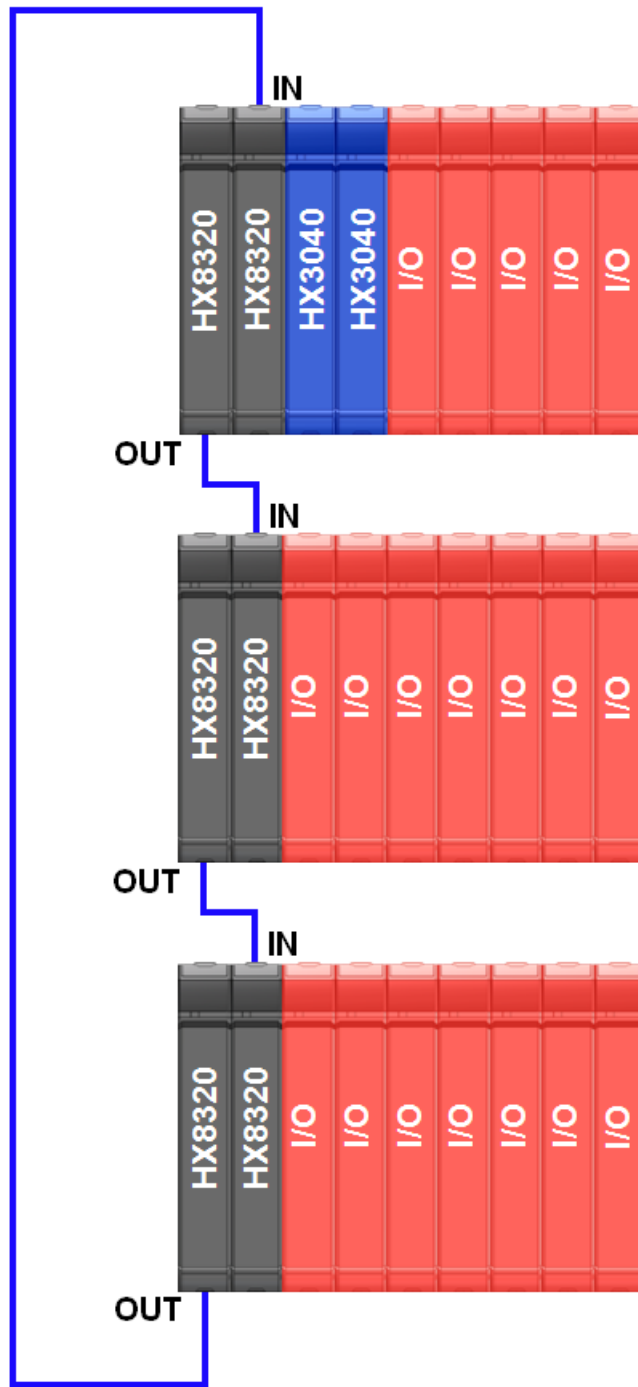

Figure 4: Power Supply and Bus Expansion Redundancy with Loopback

### 5.6.4. Configuration D: Bus Expansion with Nexto Series

The Hadron Xtorm series has compatibility with all versions of MasterTool Xtorm, with bus expansion support, carried out through the HX8320 module. With the HX3040 CPU model it is possible to expand the architecture for up to 16 racks (main rack + 15 expansion racks) using bus expansion functionality. In this case, the maximum number of modules among all expansion racks may not exceed 80.

It is also possible to mount a mixed architecture using the Hadron Xtorm series expansion bus to interconnect with a Nexto series rack. In this case, only one rack with I/O modules and a Nexto series bus expansion module can be used. The figure below shows this architecture.

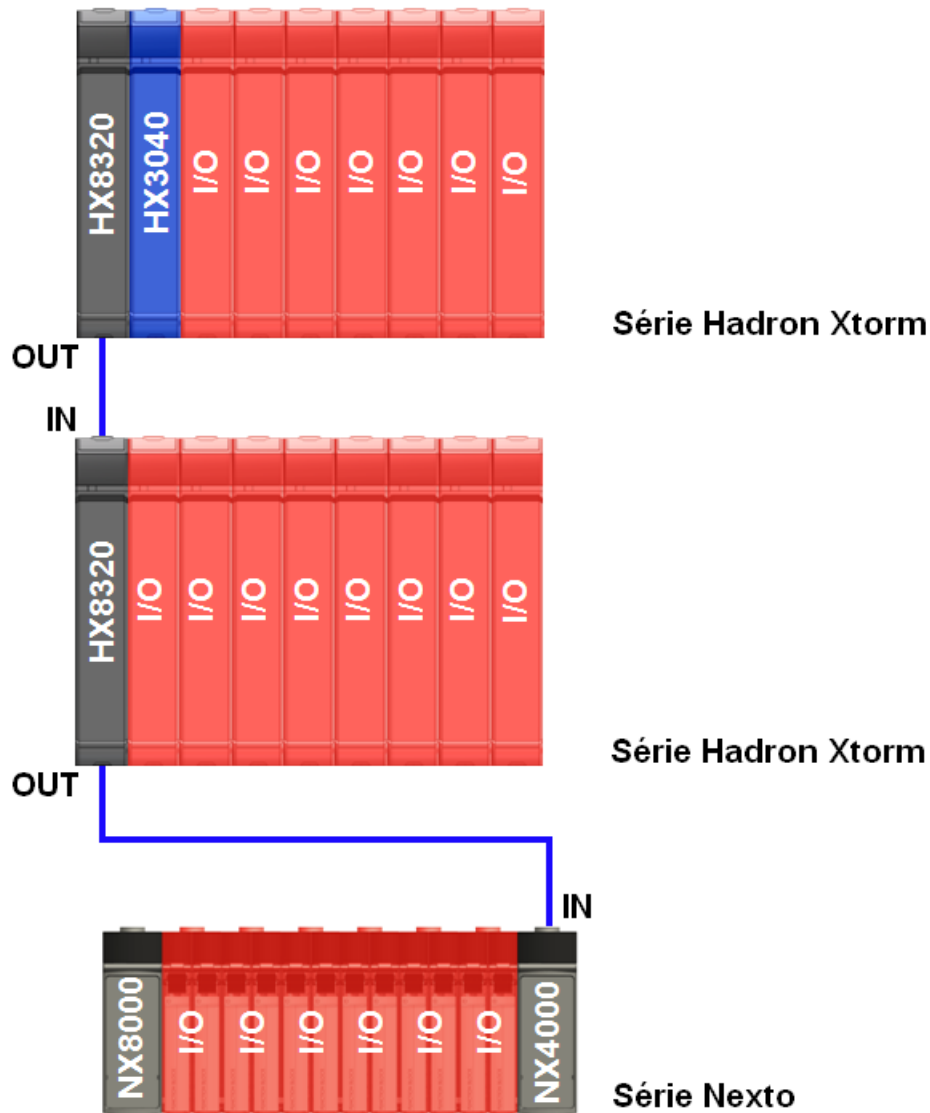

Figure 5: Bus Expansion with Nexto Series

### ATTENTION

For mixed architecture, with Nexto Series, only I/O modules are allowed. Other Nexto series modules, such as NX5000, NX5001 and NX4010, cannot be installed in Hadron Xtorm series expansion buses mixed with Nexto series.

The following table provides information regarding firmware versions of the Nexto I/O modules, which are compatible with the mixed architecture, using Nexto and Hadron Xtorm series expansion buses.

Module name	Compatible software version
NX1001	V1.2.0.2
NX1005	V1.2.0.3
NX2001	V1.2.0.2
NX2020	V1.2.0.2
NX6000	V1.2.0.2
NX6100	V1.2.0.1

Table 6: Compatible Software Versions

**Note:**

**Review:** If the software is updated in the field, the product review indicated on the label will no longer match the actual product review.

## 6. Installation

For the correct installation of this product, it is necessary to use a rack (backplane rack) and it must be carried out according to the mechanical and electrical installation instructions that follow.

**DANGER**

HX8320 power supply may operate with voltages of up to 150 Vdc. Special care must be taken during installation, which only trained technicians should perform. Do not touch the field wire or the housing when operating.

### 6.1. Electrical Installation

#### 6.1.1. HX8300 Module Installation

The following diagram shows the electrical installation of the HX8300 module.

The HX8300 module must be placed at position 0 or 1 of the Hadron Xtorm series rack, depending on the chosen architecture.

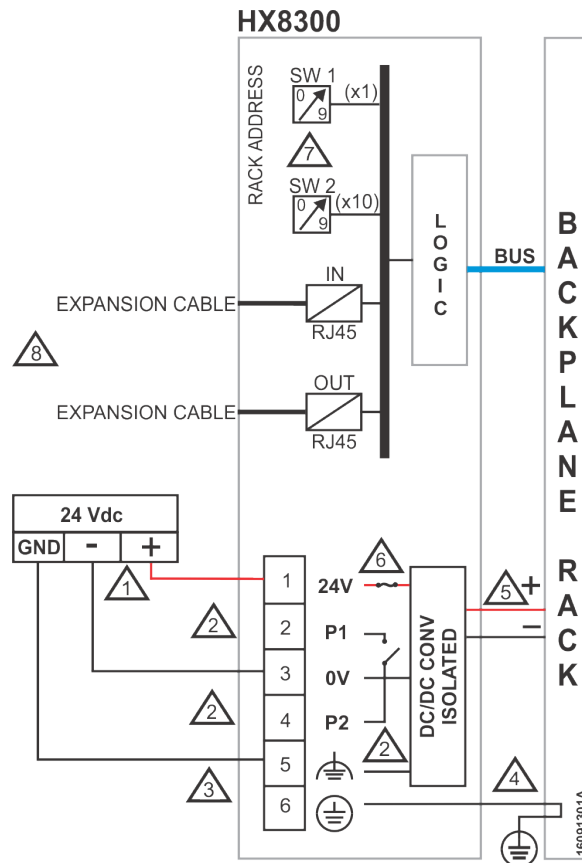











Figure 6: HX8300 Module Installation

## Diagram Notes:

-  The power supply must be connected to terminals 24 Vdc and 0 Vdc. It is recommended to use 2.5 mm<sup>2</sup> cables.
-  NO dry contact that indicates power supply operation, available through the connectors P1 and P2. It must be connected to input modules to verify the power supply operation. Normal operation is indicated by the relay driving (contacts closed).
-  The grounding from the external power supply must be connected to the terminal . For that it is recommended to use 2.5 mm<sup>2</sup> cables.
-  The rack is grounded through the interconnection with Hadron Xtorm series power supply.
-  The HX8300 module supplies the other modules through the connection with the rack.
-  Input protection with internal fuse, accessible through the front panel of the module.
-  Rack's address key.
-  Bus expansion RJ45 input and output interface.
-  Protective conductor terminal.

### 6.1.2. HX8320 Module Installation

The following diagram shows the electrical installation of the HX8320 module.

The HX8320 module must be placed at position 0 or 1 of the Hadron Xtorm series rack, depending on the chosen architecture.

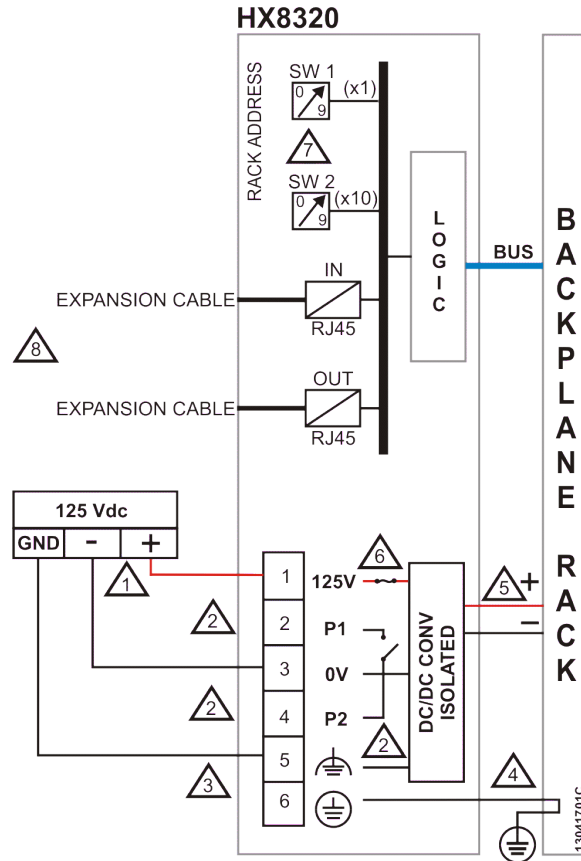



Figure 7: HX8320 Module Installation

**Diagram Notes:**

- ⚠ 1 The power supply must be connected to terminals 125 Vdc and 0 Vdc. It is recommended to use 2.5 mm<sup>2</sup> cables.
- ⚠ 2 NO dry contact that indicates power supply operation, available through the connectors P1 and P2. It must be connected to input modules to verify the power supply operation. Normal operation is indicated by the relay driving (contacts closed).
- ⚠ 3 The grounding from the external power supply must be connected to the terminal . For that it is recommended to use 2.5 mm<sup>2</sup> cables.
- ⚠ 4 The rack is grounded through the interconnection with Hadron Xtorm series power supply.
- ⚠ 5 The HX8320 module supplies the other modules through the connection with the rack.
- ⚠ 6 Input protection with internal fuse, accessible through the front panel of the module.
- ⚠ 7 Rack's address key.
- ⚠ 8 Bus expansion RJ45 input and output interface.
-  Protective conductor terminal.

## ATENÇÃO

IN and OUT expansion bus Interfaces must be connected only in modules HX8300, HX8320 or NX4000 (in the case of interconnection with Nexto series rack) and/or converters for optical fiber network. The connection of these interfaces in switches or other equipment may result in system malfunction.

## 6.2. Mechanical Assembly

Information and guidance on the correct mechanical installation can be found in the Hadron Xtorm User Manual – MU223100.

### ATTENTION

Products with broken warranty seal are not covered in warranty.

### CAUTION



The device is sensitive to static electricity (ESD). Always touch in a metallic grounded object before handling it.

### DANGER



Hadron Xtorm Series can operate with voltage up to 250 Vac. Special care must be taken during the installation, which should only be performed by qualified technical personnel. Do not touch the field wiring when in operation.

### 6.3. Physical Dimensions

Dimensions in mm.

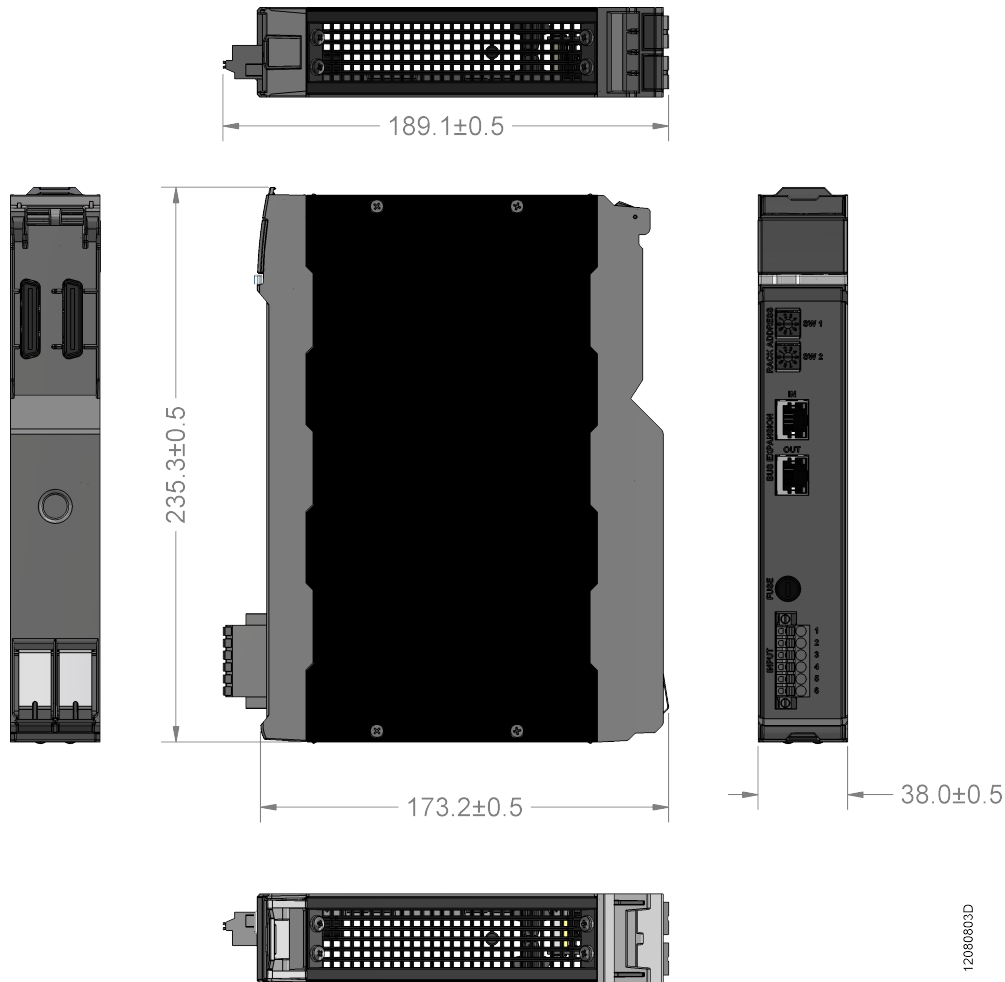

Figure 8: Physical Dimensions

### 6.4. Module Parameters

Name	Description	Default Valor	Options	Configuration
Rack number	Sets the rack number	0	0 a 31	Per module
Expansion cable type	Expansion cable type connected to IN or OUT port of the module	Not connected	Not connected NX9202 (2m) NX9202 (5m) NX9210 (10m) Customizable	Per module

Table 7: Module Parameters

**Note:**

Only the local rack can, and should be addressed as address 0.



## 7. Maintenance

Altus recommends that all modules' connections should be checked and any dust or any kind of dirt in the module's enclosure should be removed at least every 6 months.

The modules HX8300 and HX8320 offer important features to assist users during maintenance: Electronic Tag on Display, One Touch Diag, Status and Diagnostics Indicators, Web Page with Complete Status and Diagnostics List and Status and Diagnostics Mapped to Variables.

### 7.1. Electronic Tag on Display and One Touch Diag

Electronic Tag on Display and One Touch Diag are important features that provides to the user the chance to check the tag, description and diagnostics related to a given module directly on the CPU display.

To check the module tag and diagnostics of a given module, it's required only one short press on its diagnostic switch. After press once, CPU will start to scroll tag information and diagnostic information of the module. To access the respective description for the module just long press the diagnostic switch of the respective module.

More information about Electronic Tag on Display can be found at Hadron Xtorm User Manual – MU223100.

### 7.2. Status and Diagnostic Indicators

HX8300 and HX8320 Hadron Xtorm Series modules have a display and a bi-color LED to represent the diagnostics with the following symbols: D, E,  and numerical characters. The states of the symbols D and E are common for all Hadron Xtorm Series slaves modules; these states can be consulted in the table below. The same D and E symbol states are indicated by the color of the LED in module front panel.

The meaning of the numerical characters may be different for specific modules.

#### 7.2.1. D, E and Diagnostics LED (DL) States

Symbol D	Symbol E	DL (color)	Description	Cause	Solution	Priority
Off	Off	Off	Display fail or module off	Disconnected module. No external supply or hardware fail	Check if the module is completely connected to the backplane rack and if the backplane rack is supplied by an external power supply	-
On	Off	On (Blue)	Normal use	-	-	7 (lower)
Blinking 1x	Off	Blinking 1x (Blue)	Active Diagnostics	There is at least one active diagnostic related to this module	Check what the active diagnosis is. More information can be found in the Maintenance section of this document	6
Blinking 2x	Off	Blinking 2x (Blue)	CPU in STOP mode	CPU in STOP mode	Check if CPU is in RUN mode. More information can be found on CPU's documentation	5

Symbol D	Symbol E	DL (color)	Description	Cause	Solution	Priority
Blinking 4x	Off	Blinking 4x (Blue)	Hardware non fatal error	Hardware fault	The module remains with its main functionality, but in order to correct the fault, Altus support team must be contacted	4
Off	Blinking 1x	Blinking 1x (Red)	Parameterization Error	The module isn't parameterized or received an invalid parameter	Check if the module parameterization is correct	3
Off	Blinking 2x	Blinking 2x (Red)	Loss of master	Loss of communication between module and CPU	Check if the module is completely connected to the backplane rack. Check if CPU is in RUN mode	2
Off	Blinking 4x	Blinking 4x (Red)	Hardware fatal error	Hardware fault	Contact Altus support team in case of hardware fatal error	1 (higher)

Table 8: D, E and Diagnostics LED (DL) States

**Note:**

Any signaling pattern different from the above listed indicates that the module must be forwarded to the Altus support.

**7.2.2. 0, 1 and Numerical Characters**

The segments 0 and 1 are normally turned off. These segments will flash when the module is in diagnostic mode (Tag on Display and One Touch Diag).

**7.2.3. RJ45 Connectors LEDs**

There are two LEDs on RJ45 connectors, but only one possess functionality, and assists the user in detecting problems in physical network installed, indicating the existence of communication traffic with the interface. The meaning of the LEDs is presented in the table below.

LED	Meaning
Off	No network LINK
On	Active network LINK
Blinking	Transmission or reception in progress

Table 9: RJ45 Connectors LEDs

**7.3. Web Page with Complete Status and Diagnostics List**

Another way to access diagnostic information on Hadron Xtorm Series is via web page. Hadron Xtorm Series CPU's has an embedded web page server that provides all status and diagnostic information, which can be accessed using a simple browser.

More information about web page with complete status and diagnostic list can be found at Hadron Xtorm User Manual – MU223100.

### 7.4. Diagnostics Mapped through Variables

All modules diagnostics can be accessed through variables that can be handled by the user application or even forwarded to a supervisory system using a communication channel. The table below shows all available diagnostics for the modules and their respective symbolic variables, description and string that will be shown on the CPU graphical display and web.

#### 7.4.1. General Diagnostics

Diagnostic Message	Symbolic Variable DG_modulename.tGeneral.	Description
UNKNOWN DIAGNOSTIC	bReserved_08..15	Reserved
MODULE W/ DIAGNOSIS	bActiveDiagnostics	TRUE – Module has active diagnostics
NO DIAG		FALSE – Module doesn't have active diagnostics
MODULE W/ FATAL ERROR	bFatalError	TRUE – Module with fatal error FALSE – Module without fatal error
CONFIG. MISMATCH	bConfigMismatch	TRUE – Parameterization error FALSE – Parameterization OK
WATCHDOG ERROR	bWatchdogError	TRUE – Watchdog has been detected FALSE – No watchdog detected
OTD SWITCH ERROR	bOTDSwitchError	TRUE – Failure on the diagnostic switch FALSE – No failure on the diagnostic switch
UNKNOWN DIAGNOSTIC	bReserved_05..06	Reserved
BUS COM. ERROR	bCommunicationError	TRUE – failure in module communication with the bus FALSE – module communication with the bus is OK

Table 10: General Diagnostics

#### 7.4.2. Detailed Diagnostics

Diagnostic Message	Symbolic Variable DG_modulename.tDetailed	Description
LOW TEMPERATURE	bUnderTemperatureAlarm	TRUE – Power supply temperature is under the minimum limit of -5 °C FALSE – Power supply temperature is over the minimum limit of -5 °C
HIGH TEMPERATURE	bOverTemperatureAlarm	TRUE – Power supply temperature is over the maximum limit of 110 °C FALSE – Power supply temperature is under the maximum limit of 110 °C
UNKNOWN DIAGNOSTIC	bReserved_10..15	Reserved
RACK ADDRESS CHANGED	bRackAddrChanged	TRUE – Rack address modified FALSE – Rack address not modified

Diagnostic Message	Symbolic Variable DG_modulename.tDetailed	Description
UNKNOWN DIAGNOSTIC	bReserved_01	Reserved
BUS IN LINK DOWN	bLinkDownIn	<b>TRUE</b> – BUS IN - Ethernet connection broken <b>FALSE</b> – BUS IN - Ethernet connection active
BUS OUT LINK DOWN	bLinkDownOut	<b>TRUE</b> – BUS OUT - Ethernet connection broken <b>FALSE</b> – BUS OUT - Ethernet connection active
BUS IN LINK INVALID	bInvalidLinkIn	<b>TRUE</b> – BUS IN - Ethernet connection invalid <b>FALSE</b> – BUS IN - Ethernet connection valid
BUS OUT LINK INVALID	bInvalidLinkOut	<b>TRUE</b> – BUS OUT - Ethernet connection invalid <b>FALSE</b> – BUS OUT - Ethernet connection valid
LOW INPUT VOLTAGE	bLowInputVoltage	<b>TRUE</b> – Power supply input voltage is under the minimum limit <b>FALSE</b> – Power supply input voltage is over the minimum limit
LOW OUTPUT VOLTAGE	bLowOutputVoltage	<b>TRUE</b> – Power supply output voltage is under the minimum limit <b>FALSE</b> – Power supply output voltage is over the minimum limit

Table 11: Detailed Diagnostics

**Notes:**

**Symbolic Variable:** Some symbolic variables are used to access the diagnostics. All diagnostics automatically mapped in symbolic variables can be found in the Diagnostics object.

**Low Input Voltage:** This diagnosis becomes active when the value of the power supply input voltage is less than 19,2 Vdc (HX8300) or 100 Vdc (HX8320).

**Low Output Voltage:** This diagnosis becomes active when the value of the power supply output voltage is less than 4,7 Vdc.

7.4.3. Temperature Status

Status Message	Symbolic Variable DG_modulename.tTemperature	Description
POWER SUPPLY TEMPERATURE	iTemperature	Power supply temperature value

Table 12: Temperature Status

## 8. Manuals

For further technical details, configuration, installation and programming of Hadron Xtorm Series the table below should be consulted.

The table below is only a guide of some relevant documents that can be useful during the use and maintenance of HX8300 and HX8320. The complete and updated table containing all documents of Hadron Xtorm Series can be found at the Hadron Xtorm User Manual – MU223100.

<b>Code</b>	<b>Description</b>	<b>Language</b>
<b>CE123000</b>	Hadron Xtorm Series Technical Characteristics	English
<b>CT123000</b>	Características Técnicas Série Hadron Xtorm	Portuguese
<b>MU223100</b>	Hadron Xtorm User Manual	English
<b>MU223000</b>	Manual de Utilização Hadron Xtorm	Portuguese

Table 13: Manuals